

Godox 神牛



LED环形灯
LED Ring Light

LR180

深圳市神牛摄影器材有限公司
GODOX Photo Equipment Co., Ltd.

地址/Add: 深圳市宝安区福海街道塘尾社区耀川工业区厂房2栋1层至4层、4栋1层至4层
1st to 4th Floor, Building 2/ 1st to 4th Floor, Building 4, Yaochuan Industrial Zone,
Tangwei Community, Fuhai Street, Bao'an District, Shenzhen 518103, China

电话/Tel: +86-755-29609320(8062)

传真/Fax: +86-755-25723423

邮箱/E-mail: godox@godox.com

http://www.godox.com

705-LR1800-00

Made In China



Chinese English Bilingual | 中英文双语

Instruction Manual | 说明手册

七、产品参数

LED环形灯			LR180
DC电源供电			16.8V/2A
功率			约27W
色温			黑色壳体：3300K或5600K 粉色壳体：3100K或5000K
100%光照度(LUX)(1米)	黑壳	白色透光板	约600
		黄色透光板	约400
	粉壳	白色透光板	约600
		黄色透光板	约500
CRI(最大亮度)			≈92
TLCI(最大亮度)			≈97
调光范围			亮度可调
灯珠数量			180个
工作环境温度			-10~50度
产品尺寸			36.1*46*4cm
重量(带一片透光板)			880g

Foreword

Thank you for purchasing this Godox Product!

This LED Ring Light LR180 is suitable for almost all shooting occasions, which can offer lighting for live, make up, portrait shooting, video, wedding, children photography, etc. There are black version and pink version for choice.

Features:







- Two kinds of color temperature: achieve different color temperature by changing its light-passing board.

Black version: the color temperature of yellow light-passing board is 3300K while the white light-passing board is 5600K.

Pink version: the color temperature of yellow light-passing board is 3100K while the white light-passing board is 5000K.

- Stepless light brightness adjustment.

Warning

-  Always keep this product dry. Do not use in rain or in damp conditions.
-  Do not disassemble. Should repairs become necessary, this product must be sent to an authorized maintenance center.
-  Keep out of reach of children.
-  As this product do not have waterproof function, please take measures of waterproof in rainy or damp environment.
-  Do not use the flash unit in the presence of flammable gases, chemicals and other similar materials. In certain circumstance, these materials may be sensitive to the strong light emitting from this flash unit and fire or electromagnetic interference may result.
-  As this product has built-in lithium battery, do not disassemble, impact, squeeze or put it into fire. If serious bulge occurs, please do not use. Do not use or store the product if the ambient temperature reads over 50°C. Please charge the product with specialized charger and correctly operate it within the defined voltage and working temperate according to the instruction manual.

Body



- 01. Light-passing Board
- 02. Main Body
- 03. Power Switch
- 04. Select Dial for Light Brightness
- 05. DC Power Jack
- 06. Mounting Bracket
- 07. Heat Dissipation Slot
- 08. Smartphone Holder
Mirror Installation Slot

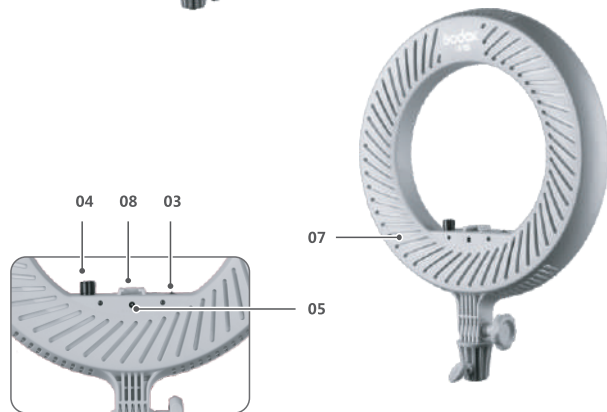

Included Items

- 1. LED ring light
- 2. Adapter
- 3. Smartphone holder
- 4. White light-passing board

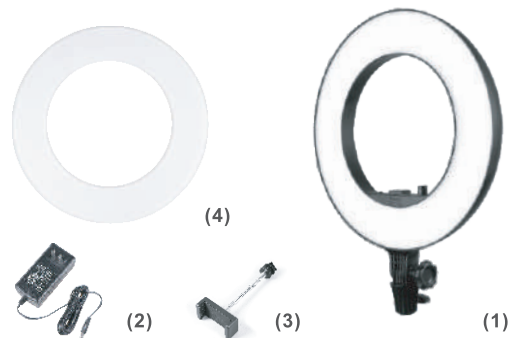

Power Management

1. Power Supply

Using DC power jack: use an adapter to connect the light with the DC power supply.



Operation

1. Before Usage

Connect the light with the DC power supply.



2. Power ON/OFF

Press the power switch to power the LED ring light on or off.



3. Light Brightness/Color Temperature Adjustment

Adjusting Light Brightness

Turn the Select Dial for Light Brightness to the counterclockwise end, and the light is in the minimum brightness. Turn the Select Dial for Light Brightness to the clockwise end, and the light is in the maximum brightness.



Adjusting Color Temperature

Change its light-passing board (the yellow light-passing board is separately sold.) to gain different color temperature.

Black version: the color temperature of yellow light-passing board is 3300K while the white light-passing board is 5600K.

Pink version: the color temperature of yellow light-passing board is 3100K while the white light-passing board is 5000K.



5. Install and Detach the Light-passing Board

Install: Aim the arrow on the light-passing board at the unlocking point and turn it towards the direction of locking point. Then, press the edges of board to make sure it is firmly fixed.

Detach: Turn the light-passing board towards the direction of unlocking point and take it out.



Technical Data

LED Ring Light			LR180
DC Power Supply			16.8V/2A
Power			Approx. 27W
Color Temperature			Black version: 3300K or 5600K Pink version: 3100K or 5000K
100% Brightness (LUX) (1M)	Black version	White light-passing board	600
		Yellow light-passing board	400
	Pink version	White light-passing board	600
		Yellow light-passing board	500
CRI(max. brightness)			≈92
TLCI(max. brightness)			≈97
Light Brightness Range			Light brightness can be adjusted.
LED Beads Quantity			180
Operation Temperature			-10~50℃
Dimension			36.1x46x4cm
Weight (with one light-passing board)			880g

FCC Statement

This device complies with part 15 of the FCC Rules. Operation is subject to the following two conditions: (1) This device may not cause harmful interference, and (2) this device must accept any interference received, including interference that may cause undesired operation.

Any Changes or modifications not expressly approved by the party responsible for compliance could void the user's authority to operate the equipment.

Note: This equipment has been tested and found to comply with the limits for a Class B digital device, pursuant to part 15 of the FCC Rules. These limits are designed to provide reasonable protection against harmful interference in a residential installation. This equipment generates uses and can radiate radio frequency energy and, if not installed and used in accordance with the instructions, may cause harmful interference to radio communications. However, there is no guarantee that interference will not occur in a particular installation. If this equipment does cause harmful interference to radio or television reception, which can be determined by turning the equipment off and on, the user is encouraged to try to correct the interference by one or more of the following measures:

- Reorient or relocate the receiving antenna.
- Increase the separation between the equipment and receiver.
- Connect the equipment into an outlet on a circuit different from that to which the receiver is connected.
- Consult the dealer or an experienced radio/TV technician for help.

Declaration of Conformity

GODOX Photo Equipment Co.,Ltd. hereby declares that this equipment are in compliance with the essential requirements and other relevant provisions of Directive 2014/30/EU. They are allowed to be used in all EU member states.

For more information of DoC, Please click this web link:

http://www.godox.com/DOC/Godox_LR180_DOC.pdf