

合格证
QC PASS

Godox



Wechat
Official Account
神牛微信公众号

深圳市神牛摄影器材有限公司

地址: 深圳市宝安区福海街道塘尾社区耀川工业区厂房2栋 电话: 0755-29609320(8062)

传真: 0755-25723423 邮箱: godox@godox.com

GODOX Photo Equipment Co., Ltd.

Add.: Building 2, Yaochuan Industrial Zone, Tangwei Community, Fuhai Street, Bao'an District,
Shenzhen 518103, China Tel: +86-755-29609320(8062) Fax: +86-755-25723423

E-mail: godox@godox.com

godox.com

Made in China | 705-XP2L00-00

UK
CA

CE

FC



X-PRO II L

TTL无线引闪器

TTL Wireless Flash Trigger

使用手册

Instruction Manual

Contents

Foreword	24	Modeling Lamp Settings	34
Warning	24	ZOOM Value Settings	34
Names of Parts	25	Buzz Settings	35
Body	25	PC Socket Settings	35
LCD Panel	26	SHOOT Function Settings	35
Battery Installation	27	Bluetooth Settings	36
Battery Level Indication	27	APP Downloading	36
As a Wireless Camera Flash Trigger	27	MENU: Setting Custom	
As a Wireless Outdoor Flash Trigger	28	Functions	37
As a Wireless Studio Flash Trigger	28	Compatible Flash Models	41
Power Switch	29	Compatible Camera Models	42
Power Saving Mode Settings	29	Technical Data	42
Power Switch of AF Assist Beam	30	Restore Factory Settings	43
Channel Settings	30	Firmware Upgrade	44
Wireless ID Settings	30	Attentions	44
Scanning Spare Channel Settings	31	Caring for Flash Trigger	45
Mode Settings	31		
Magnification Function	32		
Output Value Settings (Power Settings)	32		
Flash Exposure Compensation Settings	33		
Multi Flash Settings (Output Value, Times and Frequency)	33		

Foreword

Thank you for purchasing this XProLIL wireless flash trigger.

This wireless flash trigger applies for using Leica camera to control GODOX flash, controls the flashes with built-in Godox wireless X system e.g. camera flashes, outdoor flashes, and studio flashes. Featuring multi-channel triggering, stable signal transmission and quick response, this flash trigger benefits photographers for flexible light distribution and various shooting demands, which is suitable for hotshoe-mounted Leica cameras and cameras with PC synchronous socket. The flash trigger supports TTL flash and high-speed flash synchronization, and the maximum flash synchronization speed is up to 1 / 8000s.

* 1/8000s is achievable when the camera has a max camera shutter speed of 1/8000s.

▲ Warning

- ▲ Do not disassemble. Should repairs become necessary, this product must be sent to an authorized maintenance center.
- ▲ Always keep this product dry. Do not use in rain or in damp conditions.
- ▲ Keep out of reach of children.
- ▲ Do not use the flash unit in the presence of flammable gas. In certain circumstance, please pay attention to the relevant warnings.
- ▲ Do not leave or store the product if the ambient temperature reads over 50°C.
- ▲ Turn off the flash trigger immediately in the event of malfunction.
- ▲ Observe precautions when handling batteries
 - Use only batteries listed in this manual. Do not use old and new batteries or batteries of different types at the same time.
 - Read and follow all warnings and instructions provided by the manufacturer.
 - Batteries cannot be short-circuited or disassembled.
 - Do not put batteries into a fire or apply direct heat to them.
 - Do not attempt to insert batteries upside down or backwards.
 - Batteries are prone to leakage when fully discharged. To avoid damage to the product, be sure to remove batteries when the product is not used for a long time or when batteries run out of charge.
 - Should liquid from the batteries come into contact with skin or clothing, rinse immediately with fresh water.

Names of Parts

Body

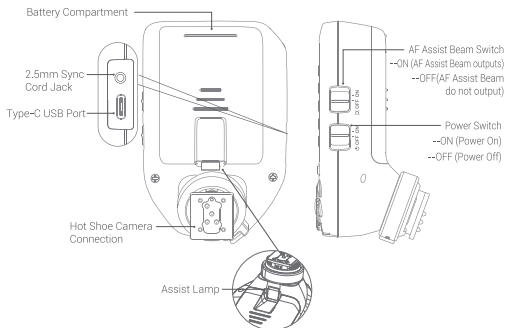
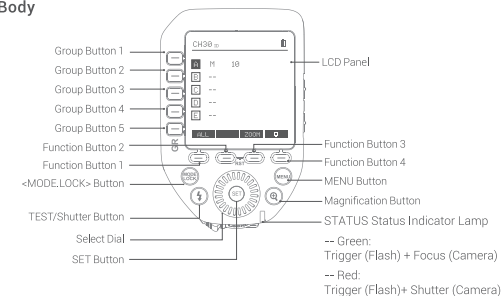

LCD Panel

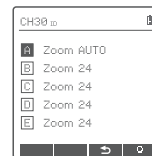
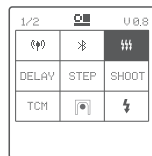
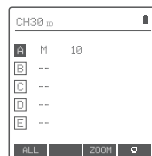
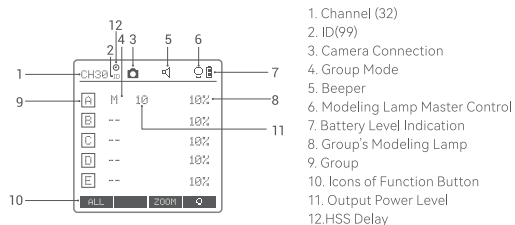





Battery Installation

Slide the battery compartment lid of the flash trigger and insert two AA batteries (optional) separately.

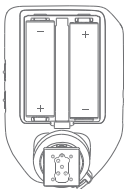
Battery Level Indication

Check the battery level indication on the LCD panel to see the remaining battery level during the usage.



Battery Level Indication	Power Status
3 grids 	Full
2 grids 	Middle
1 grid 	Low
Blank grid 	Low power , please replace it.
Blinking	2.5V The battery level is going to be used out immediately (please replace new batteries, as low power leads to no flash or flash missing in case of long distance).

The battery indication only refers to AA alkaline batteries. As the voltage of Ni-MH battery tends to be low, please do not refer to this chart.

As a Wireless Camera Flash Trigger

Take V1 series camera flash as an example:

1. Turn off the camera and mount the transmitter on camera hotshoe. Then, power on the flash trigger and the camera.
2. Short press the < MENU > Button to enter the C.Fn. menu, turn the Select Dial to < wireless function > and press the < SET > Button to set groups, mode and other parameters.



3. Turn on the camera flash, press the wireless setting button and the wireless icon and <RX> icon will be displayed on the LCD panel. Short press the < MENU > Button to enter the C.Fn. menu, press the <CH> button to set the same channel to the flash trigger, and press the <Gr> button to set the same group to the flash trigger. (Note: please refer to the relevant instruction manual when setting the camera flashes of other models)
4. Press the camera shutter to trigger and the status lamp of the flash trigger turns red synchronously.

As a Wireless Outdoor Flash Trigger

Take AD600Pro as an example:

1. Turn off the camera and mount the transmitter on camera hotshoe. Then, power on the flash trigger and the camera.
2. Short press the < MENU > button to enter the C. Fn Menu to set channel and group. Short press <MODE.LOCK> button to set flash trigger mode, turn the select dial to set flash trigger level. (refers to the contents of "Setting the Flash Trigger")
3. Power on the outdoor flash and press the wireless setting button and the wireless icon will be displayed on the LCD panel. Long press the <GR/CH> button to set the same channel to the flash trigger, and short press the < GR/CH> button to set the same group to the flash trigger (Note: please refer to the relevant instruction manual when setting the outdoor flashes of other models).
4. Press the camera shutter to trigger and the status lamp of the flash trigger turns red synchronously.



As a Wireless Studio Flash Trigger

Take QTIII as an example:

1. Turn off the camera and mount the transmitter on camera hotshoe. Then, power on the flash trigger and the camera.



- Short press the < MENU > button to enter the C. Fn Menu to set channel and group. Short press <MODE.LOCK> button to set flash trigger mode, turn the select dial to set flash trigger level. (refers to the contents of "Setting the Flash Trigger")
- Connect the studio flash to power source and power it on. Long press the MODE/Wireless button to make the wireless icon displayed on the panel and enter 2.4G wireless mode. Long press the <GR/CH> button to set the same channel to the flash trigger, and short press the < GR/CH > button to set the same group to the flash trigger (Note: please refer to the relevant instruction manual when setting the studio flashes of other models).
- Press the camera shutter to trigger. And the status lamp of the camera flash and the flash trigger both turn red synchronously.
 Note: As the studio flash's minimum output value is 1/32, the output value of the flash trigger should be set to or over 1/32. As the studio flash do not have TTL and stroboscopic functions, the flash trigger should be set to M mode in triggering.

Power Switch

Slide the Power Switch to ON, and the device is on and status indicator lamp will not reveal.

Note: In order to avoid power consumption, turn off the transmitter when not in use.

Power Saving Mode Settings

- The system will automatically enter standby mode after 60sec/30min/60min of idle use. And the displays on the LCD panel will disappear.
 Note: Dormancy time is adjustable in MENU-STBY.
- Press any button to wake up. If the flash trigger is attached to the hot shoe of CANON EOS camera, half press the camera shutter can also wake the system up.
 Note: If you don't want to set the power saving mode, press < MENU > Button to enter the C. Fn Menu and set STBY to OFF.

Power Switch of AF Assist Beam

Push the AF Assist Beam Switch up to ON, and the AF lighting is allowed output. When the camera cannot focus, the AF assist beam will turn on; when the camera can focus, the AF assist beam will turn off.

Channel Setting

- Short press the < MENU > Button to enter the C. Fn
- menu. Turn the Select Dial to select- (☺) > and press the < SET > Button to the setting page to select CH and press <SET> button to enter channel settings. Turn Select Dial to select 1-32 channels, then short press <SET> button to exit from channel settings.

Notes: please set the transmitter and the receiver to the same channel before usage.

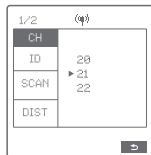

Wireless ID Settings

In addition to changing the wireless transmission channel to avoid interference, we can also change the wireless ID to avoid interference.

Note: the wireless ID and channel of lead control unit and follow control unit must be consistent before triggering.

Short press the < MENU > Button to enter the C. Fn menu. Turn the Select Dial to select- (☺) > and press the < SET > Button to the setting page, turn Select Dial to ID and short press <SET> Button to enter ID settings. Turn Select Dial to select OFF/1-99, and then short press <SET> to exit form ID settings.

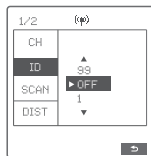

Scanning Spare Channel Settings

Scanning spare channel function is useful to avoid interference from others' using the same channel. Short press the < MENU > button to enter the Menu, turn the select dial to choose < (P) >, short press the SET button to enter the wireless setting, then turn the select dial to choose SCAN option. Short press the SET button to enter the SCAN setting interface, turn the select dial to choose START, then short press the SET button to scan from 5% to 100%, and 8 groups of spare channels will be displayed.

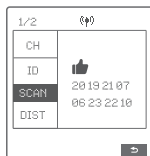

Mode Setting

Short press the group button to choose group, then short press <MODE,LOCK> button, the mode of the chosen group will change.

Set the groups to five groups (A-E) and (MULTI) is (ON):

- When displaying multiple groups, press the <MODE,LOCK > button to switch the multi-group mode to MULTI mode. Press the group selection button to choose a group, short press <MODE,LOCK > button can set the MULTI mode to ON or OFF, short press it once can exit MULTI mode.
- When displaying multiple groups, press the group selection button to choose a group, short press <MODE,LOCK > button, and all the current group's mode will be changed by the order of TTL/M/--.
- When displaying single group, short press <MODE,LOCK > button, and the current group's mode will be changed by the order of TTL/M/OFF.



Set the groups to 16 groups (0-F):

When displaying multiple groups or single group, there is only manual mode M.

Long press the <MODE,LOCK > button for 2 seconds until "LOCKED" is displayed on the bottom of the LCD panel, which means the screen is locked and no parameters can be set. Long press the <MODE,LOCK > button again to unlock.

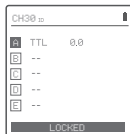

Magnification Function

Switch between multi-group and one-group mode: choose a group in multi-group mode and press the < (Q) > button to magnify it to one-group mode. Then, press the < (Q) > button to back to multi-group.

Output Value Settings (Power Settings)

Multi-group displays in the M mode

- Press the group button to choose the group, turn the select dial, and the power output value will change from Min. to 1/1 or Min. to 10 in 0.3 or 1/3 stop increments. Then, press <SET> Button to exit from this setting.
- Press Function Button 1 (<ALL> button) to choose all groups' power output value, turn the select dial, and all groups' power output value will change from Min to 1/1 or Min. to 10 in 0.3 or 0.1 stop increments. Press Function Button 1 (<ALL> button) again to confirm the setting.

One-group displays in the M mode

- Turn the select dial and the group's power output value will change from Min to 1/1 in 0.3 or 0.1 stop increments.

Note: Min. refers to the minimum value that can be set in M or Multi mode. The minimum value can be set to 1/128 0.3, 1/256 0.3, 1/512 0.3, 1/128 0.1, 1/256 0.1, 1/512 0.1, 3.0 (0.1), 2.0 (0.1) and 1.0 (0.1) according to MENU-STEP. For most of camera flashes, the minimum output value is 1/128 or 1/128(0.1) and cannot be set to 1/256 or 1/256 (0.1). However, the value can change to 1/256 or 1/256(0.1) when using in combination with Godox strong power flashes e.g. AD600Pro, etc.

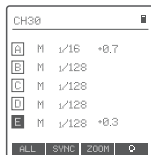

Flash Exposure Compensation Settings

Multi-group displays in the TTL mode

1. Press the group button to choose the group, turn the select dial, and the FEC value will change from -3 to ~3 in 0.3 stop increments. Press the <SET> button to confirm the setting.
2. Press Function Button 1 (<ALL> button) to choose all groups' FEC value, turn the select dial, and all groups' FEC value will change from -3 to 3 in 0.3 stop increments. Press Function Button 1 (<ALL> button) again to confirm the setting.

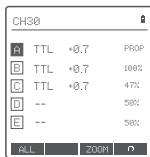

One-group displays in the TTL mode

1. Turn the select dial and the group's power output value will change from -3 to 3 in 0.3 stop increments.

Multi Flash Settings (Output Value, Times and Frequency)

Conditions for setting the multi flash parameters: 5 (A-E) should be selected in the menu <PP>GROUPS, and multi flash should be turned on.

When displaying multiple groups, short press the <MODE.LOCK> button to enter multi flash setting interface.

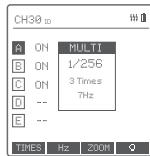

1. In the multi flash (TTL and M icon are not displayed).
2. The three lines are separately displayed as power output value (1/128~1/4), Times (flash times) and Hz (flash frequency).
3. Turn the Select Dial to change the power output value from 1/128 to 1/4 in integer stops
4. Short press the Function Button 1 (TIMES button) can change flash times. Turn the select dial to change the setting value.
5. Short press the Function Button 1 (HZ button) can change flash frequency. Turn

the select dial to change the setting value.

6. Until any value or three values are set, short press the <MODE.LOCK> button to exit the setting status.

Note: As flash times are restricted by flash output value and flash frequency, the flash times cannot surpass the upper value that permitted by the system. The times that transported to the receiver end are a real flash time, which is also related to the camera's shutter setting.

Note: Min. refers to the minimum value that can be set in M or Multi mode. The minimum value can be set to 1/128 0.3, 1/256 0.3, 1/128 0.1, 1/256 0.1, 1/512 0.1, 3.0 (0.1), 2.0 (0.1) and 1.0 (0.1) according to MENU-STEP.

Modeling Lamp Settings

1. When displaying multiple groups, press the Function Button 4 button to control the ON/OFF of the modeling lamp.
2. Press the group button to choose the group when displaying multiple groups, press the Function Button 4 button to control the status of the modeling lamp: OFF (--), Percentage value (10%-100%) or PROP (auto mode, changes with the flash brightness)

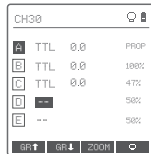

When the modeling lamp is in the percentage value status, long press the Function Button 4 to enter the modeling lamp brightness value setting interface, and turn the select dial to select the desired modeling lamp percentage value.

When displaying a single group, it is the same as the above-mentioned multiple groups display operation.

(note: The models that can use one-group to ON/OFF the modeling lamp are as follows: GSII, SKII, QSII, QDII, DEII, DPII series, etc. The outdoor flash AD200 and AD600 can use this function after upgrade. The new arrivals with modeling lamps can also use this function.).

ZOOM Value Settings

Short press the Function Button 3 and the ZOOM value will be displayed on the LCD panel. Choose the group and turn the select dial, and the ZOOM value will change from AUTO/24 to 200. Choose the desired value and long press the Function Button again to back to the main menu.

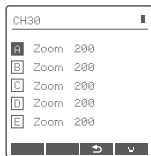

Buzz Settings

Press the < MENU > Button to enter the C, Fn menu, turn the Select Dial to <  >, press the < SET > Button to enter and turn the Select Dial to select ON/OFF turned on or off.

Then press the < MENU > Button return to the main menu.

When choosing ON, the beeper is turned on.

When choosing OFF, the beeper is turned off.

PC Socket Settings

Press the <MENU> button to enter C.Fn menu, turn the select dial to <PC>, and press the <SET> button to enter

PC socket setting to choose IN or OUT. Press the

<MENU> button again to back to the main menu.

When choosing IN, it will enable XProILL to trigger flash.

When choosing OUT, it will send trigger signals to trigger other flash.



SHOOT Function Settings

Press the < MENU > Button to enter the C.Fn menu and turn

the Select Dial to select <SHOOT>, then short press the <

SET> button and turn Select Dial to select One-shoot/

Multi-shoots/L-858, after that press <MENU> Button return to the main menu.

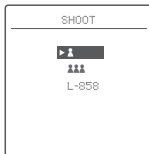

One-shoot: When shooting, choose one-shoot. In the M and Multi mode, the lead unit only sends triggering signals to the follow unit, which is suitable for one person photography for the advantage of power saving.

Multi-shoots: When shooting, choose multi-shoots, and the lead unit will send parameters and triggering signals to the follow unit, which is suitable for multi person photography. However, this function consumes power quickly.

L-858: The flash parameters can be adjusted directly on Sekonic L-858 Light Meter when collocating with it, and the transmitter only transmits SYNC signal.

Bluetooth Settings

Check Bluetooth MAC code: Short press the MENU button to enter the C.Fn menu, turn the select dial to select <  >, then short press the SET button to enter the Bluetooth setting interface, and the Bluetooth MAC code is displayed in the bottom right corner.

Bluetooth Reset: Short press the MENU button to enter the C.Fn menu, turn the select dial to select <  >, then short press the SET button to enter the Bluetooth setting interface, turn select dial to choose "RESET" and short press the SET button to enter "RESET", then you can reset the Bluetooth as you wish. It will automatically return to the previous setting interface after the reset is completed.

APP Downloading

Scan the following QR code to download "Godox Flash" APP. (available for both Android and iOS systems)





For more smartphone APP operations, please open the "help" in the APP to gain detailed guidance.

Note: the APP can be used directly on the firstly installed device (smartphone or tablet). When changing to other mobile device, the light shall be reset before the normal usage of APP.





The Bluetooth initial password is 000000.





MENU: Setting Custom Functions

The following table lists the available and unavailable custom functions of this flash:

Icons	Functions	Setting Icons	Settings and Description
	Wireless	CH	32: 1-32
		ID	OFF: off 1-99: optional 01-99 Choose any figure from 01-99
		SCAN	OFF: off START: Start scanning spare channel
		DIST	1-100m:1-100m triggering 0-30m:0-30m triggering
		GROUPS	5(A-E): 5 groups 16 (0-F):16 groups
	Bluetooth	BLUE.T	OFF: off ON: on
		RESET	CANCEL: cancel RESET: Bluetooth reset

Icons	Functions	Setting Icons	Settings and Description
	Multi flash	ON	Turn on multi flash
		OFF	Turn off multi flash
DELAY	HSS delay	OFF	Turn off HSS delay
		0.1ms-9.9ms	0.1ms-9.9ms: HSS delay range
STEP	Power output value	1/128 0.3	The minimum output is 1/128 (change in 0.3 step)
		1/256 0.3	The minimum output is 1/256 (change in 1/3 step)
		1/512 0.3	The minimum output is 1/512 (change in 1/3 step)
		1/128 0.1	The minimum output is 1/128 (change in 0.1 step)
		1/256 0.1	The minimum output is 1/256 (change in 0.1 step)
		1/512 0.1	The minimum output is 1/512 (change in 0.1 step)
		3.0 (0.1)	The minimum output is 3.0 (change in 0.1 step)
		2.0 (0.1)	The minimum output is 2.0 (change in 0.1 step)
		1.0 (0.1)	The minimum output is 1.0 (change in 0.1 step)

Icons	Functions	Setting Icons	Settings and Description
SHOOT		One-shoot	Only send triggering signals in the M & Multi mode when camera is shooting
		Full-shoot	Send parameters and triggering signal when camera is shooting (suitable for multi person photography)
	Connect to L-858	L-858	The flash parameters can be adjusted directly on Sekonic L-858 Light Meter when collocating with it, and the transmitter only transmits SYNC signal
TCM	TCM transform function	OFF	turn off TCM transform function
			TT685II/V860III series
		100j	AD100Pro
		200j	AD200
		300j	AD300Pro
		360j/400j	AD400Pro
		600j	AD600,AD600PRO
		1200j	AD1200Pro
			Legacy hot shoe
ON	turn on legacy hot shoe, TTL flash is unavailable, HSS function is also unavailable		

Icons	Functions	Setting Icons	Settings and Description
	TEST button	TRIGGER	Trigger testing
		SHUTTER	Shutter testing
PC	PC socket	IN	In port, enable XProIII to trigger flash
		OUT	Out port, send trigger signals to trigger other flash
	Beeper	OFF	turn off Beeper
		ON	turn on Beeper
	Sleep	60 sec	Enter sleep mode after 60 seconds of idle use
		30 min	Enter sleep mode after 30 minutes of idle use
		60 min	Enter sleep mode after 60 minutes of idle use
		OFF	turn off sleep mode
LIGHT	Backlighting	12sec	LCD panel and buttons backlight off in 12 seconds
		OFF	LCD panel and buttons backlight always off
		ON	LCD panel and buttons backlight always lighting
	LCD contrast ratio	-3-+3	The contrast ration can be set as integral number from -3 to +3

Icons	Functions	Setting Icons	Settings and Description
USER	Preset	SAVE	SAVE: 1-5
		LOAD	Import: 1-5
CLEAR	Clear function	CANCEL	CANCEL
		CLEAR	Clear data from menu

Note: Short press the <  > function button 4 to return to the previous setting.

Compatible Flash Models

Transmitter	Receiver	Flash models
XPROIIL	---	V860III Series, V1 Series, AD100Pro, AD200, AD200Pro, AD300Pro, AD400Pro, AD600Pro, AD1200Pro, P2400 Note 1: Firmwares of the above flashes must support XPROIIL. Quicker III Series Studio Flashes Note 2: Firmware versions of the above flashes must be V1.5 or above to support HSS of XPROIIL.

Note: The range of support functions: the functions that are both owned by XPROIIL and flash.

Compatible Camera Models

This flash trigger can be used on the following Leica camera models:

SL2	SL	M10	CL	Q2
-----	----	-----	----	----

- This table only lists the tested camera models, not all Leica EOS series cameras. For the compatibility of other camera models, a self-test is recommended.
- Rights to modify this table are retained.

▲ Caution:

There are shining edges in HSS flash when collocating with certain models.

There are missing flashes in quickly continuous shootings when collocating with certain models.

Technical Data

Model	XPROIIL
Compatible cameras	Leica cameras (TTL autoflash) Cameras that have PC sync socket.
Power supply	2*AA batteries
Flash Exposure Control	
TTL autoflash	Yes
Manual flash	Yes
Stroboscopic flash	Yes
Functions	
High-speed sync	Yes (Set on cameras)
Second- curtain sync	Yes (Set on cameras)
Flash exposure compensation	±3EV(exposure value) , adjustable in 1/3 EV increment
Flash exposure lock	Yes
Focus assist	Yes
Modeling lamp flash	Control the modeling lamp flash by flash trigger
Beeper	Control the Beeper by flash trigger
Wireless Shutter	The receiver end can control the camera shooting through the 2.5mm sync cord jack

ZOOM setting	Adjust the ZOOM value by the transmitter from AUTO or 24 to 200
TCM function	Transform the TTL shooting value into the output value in the M mode
Firmware upgrade	Upgrade through the Type-C USB port
Memory function	Settings will be stored 2 seconds after last operation and recover after a restart
Display	Large LCD panel, backlighting ON or OFF
Wireless Flash	
Transmission range (approx.)	0-100m
Built-in wireless	2.4GHz
Modulation mode	MSK
Channel	32
Wireless ID	01-99
Group	16
Other	
Dimension	95mm*62mm*49mm
Net Weight	93g
2.4G Wireless Frequency Range	2413.0MHz-2464.5MHz
Bluetooth Transmission Frequency	2402.00MHz -2480.00MHz
Max. Transmitting Power	5dbm

Restore Factory Settings

Synchronously press the two function buttons in the middle for 2 seconds, the "RESET" is displayed on the LCD panel with CANCEL and OK options, choose OK and short press SET button, it will automatically return to the main interface after the restore factory settings are finished.

Firmware Upgrade

This flash trigger supports firmware upgrade through the Type-C USB port. Update information will be released on our official website.

Note: USB connection line is not included in this product. As the USB port is a Type-C USB socket, please use Type-C USB connection line.

As the firmware upgrade needs the support of Godox G3 software, please download and install the "Godox G3 firmware upgrade software" before upgrading. Then, choose the related firmware file.

Attentions

1. Unable to trigger flash or camera shutter. Make sure batteries are installed correctly and Power Switch is turned on.

Check if the transmitter and the receiver are set to the same channel, if the hotshoe mount or connection cable is well connected, or if the flash triggers are set to the correct mode.
2. Camera shoots but does not focus. Check if the focus mode of the camera or lens is set to MF. If so, set it to AF.
3. Signal disturbance or shooting interference. Change a different channel on the device.

The Reason & Solution of Not Triggering in Godox 2.4G Wireless

1. **Disturbed by the 2.4G signal in outer environment (e.g. wireless base station, 2.4G wifi router, Bluetooth, etc.)**

→ To adjust the channel CH setting on the flash trigger (add 10+ channels) and use the channel which is not disturbed. Or turn off the other 2.4G equipment in working.
2. **Please make sure that whether the flash has finished its recycle or caught up with the continuous shooting speed or not (the flash ready indicator is lighten) and the flash is not under the state of over-heat protection or other abnormal situation.**

→ Please downgrade the flash power output. If the flash is in TTL mode, please try to change it to M mode (a preflash is needed in TTL mode).

3. Whether the distance between the flash trigger and the flash is too close or not

→ Please turn on the "close distance wireless mode" on the flash trigger (<0.5m):
→ Please set the MENU- (F1) -DIST to 0-30m

4. Whether the flash trigger and the receiver end equipment are in the low battery states or not

→ Please replace the battery (the flash trigger is recommended to use 1.5V disposable alkaline battery).

Caring for Flash Trigger

Avoid sudden drops. The device may fail to work after strong shocks, impacts, or excess stress.

Keep dry. The product isn't water-proof. Malfunction, rust, and corrosion may occur and go beyond repair if soaked in water or exposed to high humidity.

Avoid sudden temperature changes. Condensation happens if sudden temperature changes such as the circumstance when taking the transceiver out of a building with higher temperature to outside in winter. Please put the transceiver in a handbag or plastic bag beforehand.

Keep away from strong magnetic field. The strong static or magnetic field produced by devices such as radio transmitters leads to malfunction.

▲ Warning

Operating frequency: 2412.99MHz – 2464.49MHz(2.4G)/2402MHz – 2480MHz(BT)
Maximum EIRP Power: 2,55dBm/1,11dBm

Declaration of Conformity

GODOX Photo Equipment Co., Ltd. hereby declares that this equipment are in compliance with the essential requirements and other relevant provisions of Directive 2014/53/EU. In accordance with Article 10(2) and Article 10(10), this

product is allowed to be used in all EU member states. For more information of DoC, Please click this web link:

<https://www.godox.com/eu-declaration-of-conformity/>

The device complies with RF specifications when the device used at 0mm from your body.

FCC Statement

This device complies with part 15 of the FCC Rules. Operation is subject to the following two conditions:

- (1) This device may not cause harmful interference, and
- (2) this device must accept any interference received, including interference that may cause undesired operation.

Any Changes or modifications not expressly approved by the party responsible for compliance could void the user's authority to operate the equipment.

Note: This equipment has been tested and found to comply with the limits for a Class B digital device, pursuant to part 15 of the FCC Rules. These limits are designed to provide reasonable protection against harmful interference in a residential installation. This equipment generates uses and can radiate radio frequency energy and, if not installed and used in accordance with the instructions, may cause harmful interference to radio communications. However, there is no guarantee that interference will not occur in a particular installation. If this equipment does cause harmful interference to radio or television reception, which can be determined by turning the equipment off and on, the user is encouraged to try to correct the interference by one or more of the following measures:

- Reorient or relocate the receiving antenna.
 - Increase the separation between the equipment and receiver.
 - Connect the equipment into an outlet on a circuit different from that to which the receiver is connected.
 - Consult the dealer or an experienced radio/TV technician for help.
- The device has been evaluated to meet general RF exposure requirement. The device can be used in portable exposure condition without restriction.

产品保修

尊敬的用户，本保修卡是申请保修服务的重要凭证，请您配合销售商填写并妥善保管，谢谢！

产品信息	型号	产品条码
用户信息	姓名	联系电话
	通信地址	
销售商信息	名称	
	联系电话	
	通信地址	
	销售日期	
备注		

注：此表应由销售商盖章确认。

产品信息

本文件适用于相关《产品保修信息》(见后面说明)所列产品，其他非属此范围的产品或部件(如促销品、赠品及其他出厂后附加的部件等)不在此保修承诺内。

保修期

产品及部件的相应保修期按相关的《产品保修信息》执行。保修期自产品首次购买日起算，购买日以购买产品时保修卡登记日期为准。

如何获得保修服务

您可直接与产品销售商或授权服务机构联系，也可拨打神牛产品售后服务电话，与我们联系，由我们的服务人员为您安排服务。申请保修时，您应提供有效的保修卡作为保修凭证，方可获得保修。如您不能提供有效的保修卡，则在我们确认产品或部件属于保修范围的情况下，也可以为您提供保修，但这不作为我们的义务。

不适用保修的情况

如产品存在下列情况，本文件项下的保证和服务将不适用：①产品或部件超过相应保修期；②错误或不当使用、维护或保管导致的故障或损坏，如：不当搬运；非按产品合理预期用途使用；不当插拔外接设备；跌落或外力挤压；接触或暴露于不适当温度、溶剂、酸碱、水浸或潮湿环境；③由非神牛授权机构或人员安装、修理、更改、添加或拆卸造成的故障或损坏；④产品或部件原有识别信息被修改变更或除去；⑤无有效保修卡；⑥使用非合法授权、非标准或非公开发行的软件造成的故障或损坏；⑦因不可抗力或意外事件造成的故障或损坏；⑧其他非因产品本身质量问题导致的故障或损坏。遇上述情况，您应向相关责任方寻求解决，神牛对此不承担任何责任。因非在保修期或保修范围内的部件、附件或软件导致产品不能正常使用的，不是保修范围内的故障。产品使用过程中正常的脱色，磨损和消耗，不是保修范围内的故障。

产品保修和服务支持信息

产品的保修期和服务类型按以下《产品保修信息》执行：

产品类别	选件名称	保修期(月)	保修服务类型
部件	主机	12	客户送修
	电池	3	客户送修
	充电器等带电性能的部件。	12	客户送修
其他	如电源线、同步线闪光管、造型灯泡、外壳、保护罩、锁紧装置、包装等。	无	无保修

神牛产品售后服务电话 0755-29609320-8062

Warranty

Dear customers, as this warranty card is an important certificate to apply for our maintenance service, please fill in the following form in coordination with the seller and safe-keep it. Thank you!

Product Information	Model	Product Code Number
Customer Information	Name	Contact Number
	Address	
Seller Information	Name	
	Contact Number	
	Address	
	Date of Sale	
Note		

Note: This form shall be sealed by the seller.

Applicable Products

The document applies to the products listed on the Product Maintenance Information (see below for further information). Other products or accessories (e.g. promotional items, giveaways and additional accessories attached, etc.) are not included in this warranty scope.

Warranty Period

The warranty period of products and accessories is implemented according to the relevant Product Maintenance Information. The warranty period is calculated from the day (purchase date) when the product is bought for the first time. And the purchase date is considered as the date registered on the warranty card when buying the product.

How to Get the Maintenance Service

If maintenance service is needed, you can directly contact the product distributor or authorized service institutions. You can also contact the Godox after-sale service call and we will offer you service. When applying for maintenance service, you should provide valid warranty card. If you cannot provide valid warranty card, we may offer you maintenance service once confirmed that the product or accessory is involved in the maintenance scope, but that shall not be considered as our obligation.

Inapplicable Cases

The guarantee and service offered by this document are not applicable in the following cases:

① **The product or accessory has expired its warranty period;** ② **Breakage or damage caused by inappropriate usage, maintenance or preservation, such as improper packing, improper usage, improper plugging in/out external equipment, falling off or squeezing by external force, contacting or exposing to the improper temperature, solvent, acid, base, flooding and damp environments, etc;** ③ **Breakage or damage caused by non-authorized institution or staff in the process of installation, maintenance, alternation, addition and detachment;** ④ **The original identifying information of product or accessory is modified, alternated, or removed;** ⑤ **No valid warranty card;** ⑥ **Breakage or damage caused by using illegally authorized, nonstandard or non-public released software;** ⑦ **Breakage or damage caused by force majeure or accident;** ⑧ **Breakage or damage that could not be attributed to the product itself.** Once met these situations above, you should seek solutions from the related responsible parties and Godox assumes no responsibility. The damage caused by parts, accessories and software that beyond the warranty period or scope is not included in our maintenance scope. The normal discoloration, abrasion and consumption are not the breakage within the maintenance scope.

Maintenance and Service Support Information

The warranty period and service types of products are implemented according to the following Product Maintenance Information:

Product Type	Name	Maintenance Period(month)	Warranty Service Type
Parts	Circuit Board	12	Customer sends the product to designated site
	Battery	3	Customer sends the product to designated site
	Electrical parts e.g.battery charger, etc.	12	Customer sends the product to designated site
Other Items	Flash tube, power cord, sync cable,modeling lamp,lamp body, lamp cover,locking device, package, etc.	No	Without warranty

Godox After-sale Service Call +86-755-29609320(8062)