

合格证
QC PASS

Godox

V1^{Pro}_C

TTL 锂电圆头机顶闪光灯

TTL Li-ion Round Head Camera Flash



Wechat
Official Account
神牛微信公众号

深圳市神牛摄影器材有限公司

地址：深圳市宝安区福海街道塘尾社区耀川工业区厂房2栋
电话：0755-29609320(8062) 传真：0755-25723423 邮箱：godox@godox.com

GODOX Photo Equipment Co., Ltd.

Add.: Building 2, Yaochuan Industrial Zone, Tangwei Community, Fuhai Street, Bao'an District, Shenzhen 518103, China Tel: +86-755-29609320(8062)

Fax: +86-755-25723423 E-mail: godox@godox.com

www.godox.com

Made in China | 705-V1PRC0-02



使用手册

Instruction Manual

固件升级

- 本产品 USB 接口为 USB-C 接口，请使用 USB-C 数据线。
- 产品升级固件需要 Godox G3 程序软件支持，升级固件前请先下载安装 Godox G3 固件升级软件，再选择相应的固件文件。
- 由于产品进行固件升级，说明书请以最新电子版为准。

兼容相机列表

本机可兼容以下佳能 EOS 系列的相机型号：

1DX、5D Mark III、5D Mark II、6D、7D、60D、50D、40D、30D、650D、600D、550D、500D、450D、400D Digital、1100D、1000D、5D Mark IV、7D Mark II、6D Mark II、760D、750D、70D、80D、800D、77D、M5、M3、M50、EOS R、1500D、3000D、5D II、5D III、RP、90D

注：1. 此表格仅列举目前已测试的相机型号，未涵盖所有佳能 EOS 系列相机。其他相机型号，用户可自行测试。
2. 本公司保留未来修改此表格内容的权利。

维护保养

- 闪光灯在工作时，如发现异常，应立即关掉电源，查明原因。
- 灯体应避免震动，平时注意表面除尘。
- 灯体稍有发热为正常现象，无特别需要时，勿连续引闪。
- 所有维修概由本厂指定的可供原配件的维修部负责。
- 1 年保修，消耗品如灯管等，不在 1 年保修范围。
- 经发现，擅自检修此闪光灯的，将取消闪光灯之一年保修期，维修需要收取相关费用。
- 如果本品出现故障或者被水淋湿，在专业人员维修后方可继续使用。
- 如有技术更改，恕不另行通知。

Important Safety Instructions

This product is a professional photographic equipment, to be operated by professional personnel only.

The following basic safety precautions must be followed when using this product: All transport protective materials and packaging on the product must be removed before use.

1. Carefully read and fully understand the instruction manual before use and strictly follow the safety instructions. Failure to do so may result in death, serious injury, damage to the product, or other property damage.
2. This product is a professional lighting fixture, children are prohibited from using it. Children must be closely supervised by adults when approaching the fixture, to prevent collisions with the fixture or unauthorized use that could cause personal injury.
3. This is not an ordinary lighting fixture and must not be used for general illumination. Anyone with a history of eye damage or sensitivity should avoid using this fixture or looking directly at it.
4. Extreme caution must be exercised when using it, do not touch high-temperature parts such as flash tubes to avoid burns.
5. Do not point the flash directly at the eyes (especially baby's eyes) under any circumstances, as this could impair vision in a short time. Turn off immediately if discomfort occurs, stop using, and seek medical attention promptly.
6. Do not use damaged equipment or accessories. Allow professional repair technicians to inspect and confirm normal operation before continuing use after repairs.
7. Stop using immediately if the product shell is cracked due to falling, squeezing, or strong impact, to avoid touching the internal electronic components and getting an electric shock.
8. This device is not waterproof. Keep it dry and avoid immersing it in water or other liquids. It should be installed in a ventilated and dry location and avoid using in rainy, humid, dusty, or overheated environments. Do not place items above the device or allow liquids to flow into it to prevent danger.
9. Do not disassemble without authorization. If the product malfunctions, it must be inspected and repaired by our company or authorized repair personnel.
10. Before storing the device, ensure it has completely cooled down.
11. Do not place the device near alcohol, gasoline, or other flammable volatile solvents or gases such as methane and ethane.
12. Do not use or store this device in potentially explosive environments.
13. Maintain at least 1 meter distance between the lamp head and the user, other people, and heat-sensitive or flammable items during and after use.
14. Do not use accessories not been approved by our company, as this may cause fire, electric shock or personal injury.
15. Clean gently with a dry cloth. Do not use a wet cloth as it may damage the device.
16. This instruction manual is based on rigorous testing. Changes in design and specifications are subject to change without notice. Check official website for latest instruction manual and product updates.
17. This product is powered by lithium batteries, who have limited lifespans and will gradually lose their charging capacities, which is irreversible. As the battery ages, the product's battery life will decrease. The lifespan of lithium battery is estimated to be 2 to 3 years. Please regularly check the battery, and if the charging time significantly increases or the battery life significantly decreases, consider replacing the battery.
18. This product is equipped with lithium batteries. The following are the storage recommendations: Charge the battery to about 50% before storage. Charge it to about 50% at least every six

Name of Parts

Body

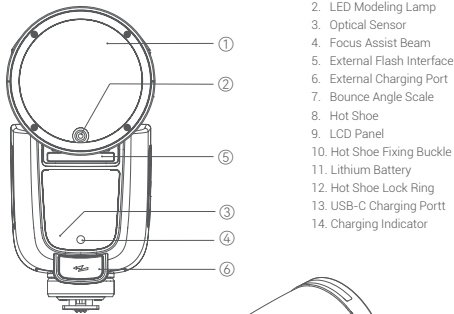

- Flash Head
- LED Modeling Lamp
- Optical Sensor
- Focus Assist Beam
- External Flash Interface
- External Charging Port
- Bounce Angle Scale
- Hot Shoe
- LCD Panel
- Hot Shoe Fixing Buckle
- Lithium Battery
- Hot Shoe Lock Ring
- USB-C Charging Port
- Charging Indicator

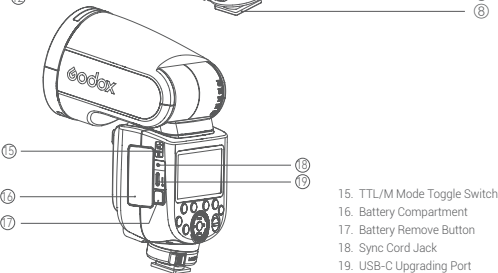
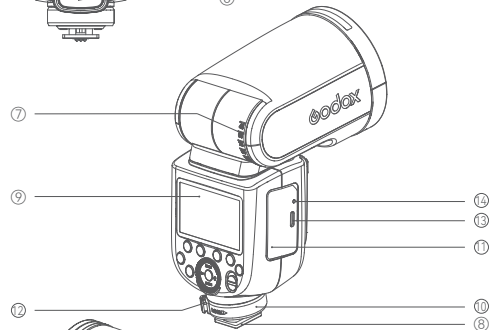

- TTL/M Mode Toggle Switch
- Battery Compartment
- Battery Remove Button
- Sync Cord Jack
- USB-C Upgrading Port

Control Panel

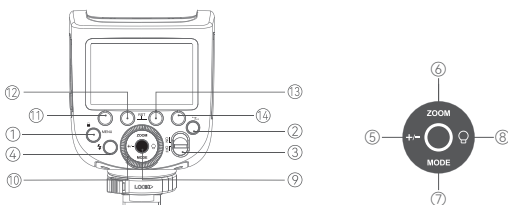

- MENU/☰ Button
- <Z> Wireless Button
- ON/OFF Power Switch
- Test Button / Recycle Indicator
- <+/-> FEC/Flash Output Setting Button
- <ZOOM> Zoom Button
- <MODE> Mode Button
- LED Modeling Lamp Button
- Set Button
- Select Dial
- Function Button 1
- Function Button 2
- Function Button 3
- Function Button 4

Detachable Sub Flash SU-1

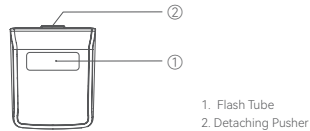

- Flash Tube
- Detaching Pusher

LCD Panel

E-TTL/E-TTL II Auto Flash

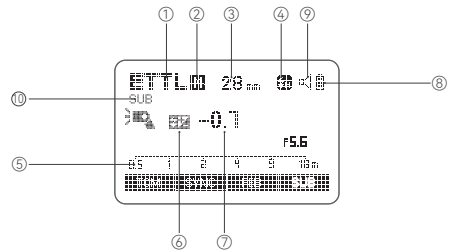

- ETTL: E-TTL II/E-TTL Auto Flash
- A: Auto Zoom M: Manual Zoom
- Zoom Display (Auto/28-105mm)
- High-Speed Sync
Second-Curtain Sync
First-Curtain Sync
- Effective Flash Range/Shooting Distance (m/ft)
- Flash Exposure Compensation
- Flash Exposure Compensation Amount
- Battery Level Indication
- Beeper
- Sub Flash SU-1 ON

Manual Flash

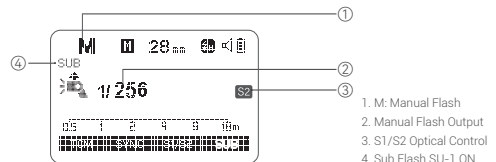

- M: Manual Flash
- Manual Flash Output
- S1/S2 Optical Control
- Sub Flash SU-1 ON

Note: 1. The display will only show the settings currently applied.
2. The functions displayed above function buttons 1 to 4, such as <SYNC and A/B/C/D>, change according to settings's status.
3. When a button or dial is operated, the LCD panel will be illuminated.
4. The <SUB> icon will display on the panel only after the sub flash is inserted into the flash.

Multi Flash

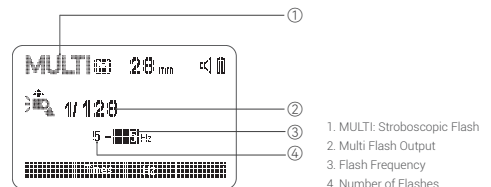

- MULTI: Stroboscopic Flash
- Multi Flash Output
- Flash Frequency
- Number of Flashes

Radio Transmission Shooting:

Transmitter Unit (2.4G Wireless Transmitting)

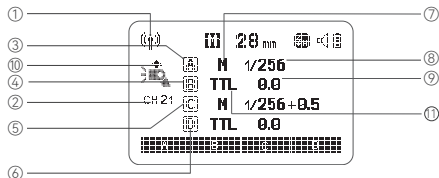

1. Radio Transmission Shooting
2. Transmitter Channel
3. Group A: Receiver Unit Group A
4. Group B: Receiver Unit Group B
5. Group C: Receiver Unit Group C
6. Group D: Receiver Unit Group D
7. M: Manual Flash
8. Flash Output
9. Flash Exposure Compensation Amount
10. Transmitter Unit Flash ON
11. TTL: TTL Auto Flash

Receiver Unit (2.4G Wireless Receiving)

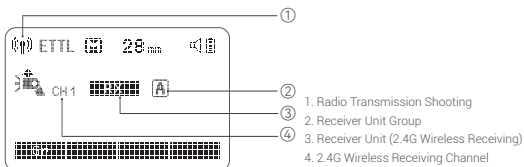

1. Radio Transmission Shooting
2. Receiver Unit Group
3. Receiver Unit (2.4G Wireless Receiving)
4. 2.4G Wireless Receiving Channel

What's Inside

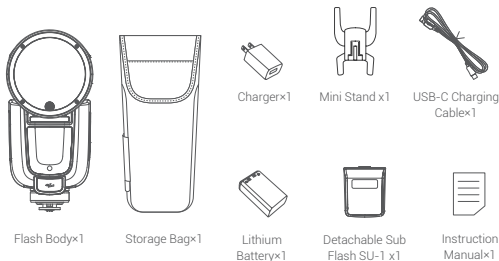

Separately Sold Accessories

The product can be used in combination with the following accessories sold separately, so as to achieve the best photography effects:

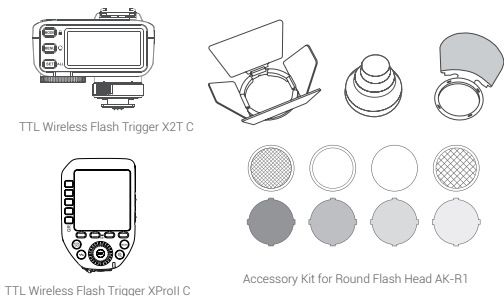

Battery

Detaching battery:

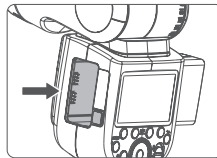

Press and hold the battery remove button, then push the battery out of the battery compartment.

Installing battery:

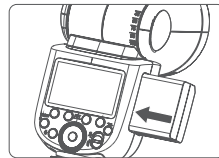

Insert the battery into the battery compartment in the direction as referred below until it's firmly locked.

Battery Level Indication

Make sure the battery pack is securely loaded in the flash. Check the battery level indication on the LCD panel to see the remaining battery level.

Battery Level Indication	Meaning
3 grids	Full
2 grids	Middle
1 grid	Low
Blank grid	Lower battery, please recharge it.
Blinking	The battery level is going to be used out, and the flash is not functional in this status. Note: Please recharge the battery as soon as possible (within 10 days). Then, the battery can be used or be placed for long period.

Power Management

Use ON/OFF power switch to power the flash unit on or off. Turn off if it will not be used for an extended period of time.

Setting as a transmitter unit, the flash will turn the power off automatically after a certain period (approx. 90 seconds) of idle use. Press the camera shutter halfway or press any flash button will wake up the flash unit. Setting as a receiver flash, it will enter sleep mode after 60 minutes (or 30 minutes) of idle use. Pressing any flash button will wake it up.

- Note:
1. Setting the C.Fn-STBY function to OFF is recommended when the flash is used off camera.
 2. Auto power off timer function of a receiver unit is set to 60 minutes by default. Another option "30 minutes" is available in C.Fn-RX.
 3. The LCD panel will lighten on when operating the buttons or select dial.

Modeling Lamp

Press the modeling lamp button to set the modeling lamp, press the set button to turn on or off the modeling lamp. When turning the modeling lamp on, turn the select dial to adjust its brightness in 10 levels (01~10).

Press the function button 1 <MODEL> to switch modeling lamp, the modeling lamp icon will be off <OFF> or on <ON>.

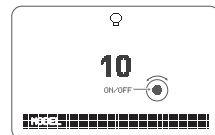

Mounting/Detaching the Camera Flash

Mounting the camera flash:

Press the hot shoe fixing buckle and rotate it to the left, insert the camera flash into the camera's hot shoe.

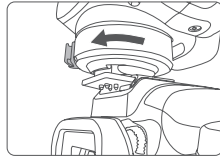

Then rotate it to the right until it locks up.



Detaching the camera flash:

Press and rotate the hot shoe fixing buckle to the left until it is loosened, then take off the camera flash.

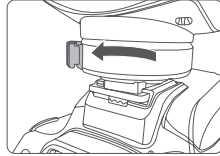

Installing/Detaching SU-1

Installing:

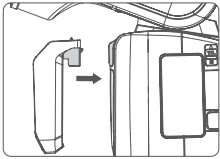

Align the detachable sub flash SU-1 with the external flash interface of V1 Pro C and insert it parallelly, then press it down, a "click" sound means it's properly installed.

Detaching:

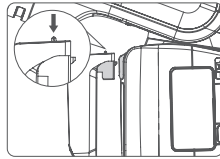

Push the detaching pusher on SU-1 and pull it up at the same time to detach it.

Note: Please turn off the V1Pro series flashes before Installing and detaching SU-1. Do not insert in or pull out SU-1 when the V1Pro series flashes are in power on status or working, otherwise malfunctions may occur.

Using SU-1

With detachable sub flash SU-1 attached to the external flash interface of V1Pro C, better filling light effects can be achieved in M (manual) flash/TTL auto flash mode, this is helpful for portrait shooting.

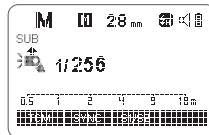

Instructions for Using

Mount SU-1 directly to the external flash interface of V1Pro C, press the function button 1 <MODE> to set the flash to M (manual) flash/TTL auto flash mode, then press function button 4 <SUB> to enter sub flash settings interface, and press function button 3 <ON/OFF> to turn on/off.



When the sub flash is turned on, turn the select dial can adjust flash output of the sub flash from 1/128 to 1/1 in 22 flash steps, with +1/3 increment each step.

- Note:
1. SU-1 is not useable in wireless transmission shooting.
 2. SU-1 is not useable in high-speed sync.
 3. The flash head need to be uplifted in order to use SU-1 properly.

Flash Mode – E-TTL Auto Flash

In E-TTL mode, the camera's metering system detects the flash reflected from the subject and automatically adjusts the flash output so that the subject and background are evenly exposed. In this mode, multiple functions are available: FEC, FEB, FEL, HSS, second curtain sync, etc.

Press <MODE> mode button to enter E-TTL mode, the LCD panel will display <ETTL>.

- Press the camera shutter halfway to focus. The aperture value and effective flash range will be displayed in the LCD panel.
- When the shutter is fully pressed, the flash will fire a pre-flash that the camera will use to calculate exposure and flash output the instant before the photo is taken.

FEC (Flash Exposure Compensation)

With FEC function, this flash can adjust from -3 to +3 with 1/3 increment each step. It is useful in situations where minor adjustment of the TTL system is needed based on the environment.

Setting FEC Amount

1. Press the <+/-> button, the <FEC> icon and FEC amount will be highlighted on the LCD panel.

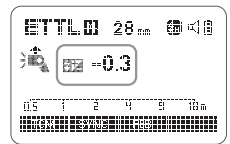
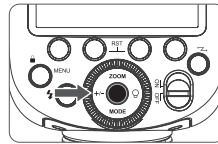

2. Turn the select dial to set the FEC amount. "0.3" means 1/3 step, "0.7" means 2/3 step. To cancel the FEC, set the amount to "0".

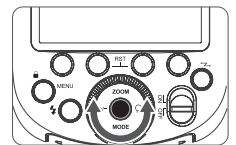

- Press set button again to confirm the setting.

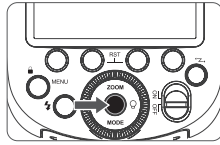

FEB (Flash Exposure Bracketing)

FEB refers to the flash will automatically change the flash output for each shot from -3 to +3 with 1/3 increment each step. With this function, the camera will record three images with different exposures: one exposed according to camera calculations, one over-exposed and another under-exposed. This function helps get correct exposure especially in shooting moving objects or when environmental lights are complex.

Setting FEB Amount

- Press function button 3 <FEB>. The  icon and the FEB amount will be highlighted on the LCD panel.

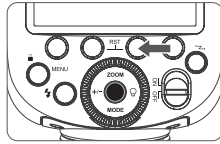

- Turn the select dial to set the amount. "0.3" means 1/3 step, "0.7" means 2/3 step.

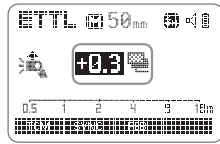

- Press set button again to confirm the setting, then the FEC and FEB settings are displayed on the LCD panel at the same time.

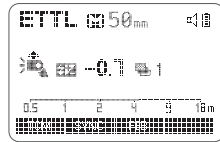

- Note:
- FEB will be cancelled after three photos are taken.
 - For best results of FEB function, set the camera drive mode to "single" and ensure the flash is ready before shooting.
 - FEB can be used with FEC and FEL.
 - You can prevent the FEB from being cancelled automatically after three photos are taken in MENU-FEB ACL.

FEL (Flash Exposure Lock)

FEL can lock the correct flash exposure setting for any part of the scene.

With <ETTL> displayed on the LCD panel, press the camera's <FEL> button. If the camera does not have a <FEL> button, press the <+> button.

- Focus the subject.
- Press the <FEL> button.

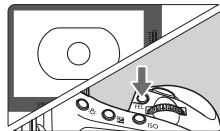

- Aim the subject at the center of the viewfinder and press <FEL> button.
- The camera flash will fire a pre-flash and the required flash output for the subject is retained in memory.
- The "FEL" will be displayed in the viewfinder for 0.5s.
- The camera flash will fire a pre-flash and the new flash exposure settings is locked every time the <FEL> button is pressed down.

- Note:
- If the subject is too far away and underexposure, the  icon will blink in the viewfinder. Please get closer to the subject and try the FEL again.
 - If <ETTL> is not displayed on the LCD panel, FEL cannot be set.
 - If the subject is too small, FEL might not be very effective.



High-Speed Sync

High speed sync (FP flash) enables the flash to synchronize with all camera shutter speeds. This is convenient when you want to use aperture priority for fill-flash portraits.

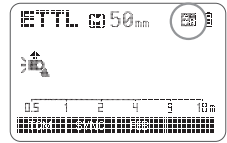
- Press function button 2<SYNC> so that the  icon is displayed on the LCD panel.



- Check whether the  icon is displayed in the viewfinder.

- Note:
- If you set a shutter speed that is the same as or slower than the camera's maximum flash sync speed,  will not be displayed in the viewfinder.
 - With high-speed sync, the faster the shutter speed, the shorter the effective flash range.
 - To return to normal flash, press <SYNC> button again. Then  will disappear.
 - Multi flash mode cannot be set in high-speed sync mode.
 - Over-temperature protection may be activated after 60 consecutive high-speed sync flashes.

Second-Curtain Sync

With a slow shutter speed and second-curtain sync, you can create a light train following the subject. The flash fires right before the shutter closes.

- Press function button 2<SYNC> so that  is displayed on the LCD panel.

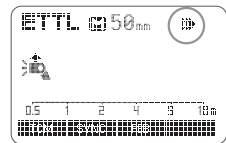
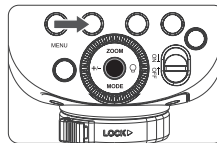

- Note:
- The second-curtain sync will have better effect in BuLb shooting.
 - The camera flash will fire twice in <ETTL> flash mode, the first of which is a pre-flash to determine the flash output, not a failure.
 - To return to normal flash, press <SYNC> button again. Then  will disappear.

Flash Mode – M: Manual Flash

The flash output is adjustable from 1/1 full power to 1/256 power with 1/10 increment each step. To obtain a correct flash exposure, use a hand-held flash meter to determine the required flash output.

1. Press <MODE> mode button so that <M> is displayed on the LCD panel.

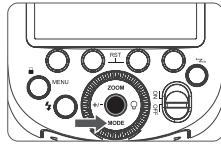

2. Press the <+/-> button to select flash output amount, then turn the select dial to adjust it. Press the set button again to confirm the setting.

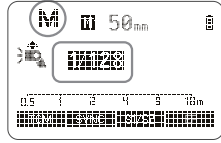

S1 Optic Control Unit Setting

In M manual flash mode, press <S1/S2> button so that this flash can function as an optic S1 secondary flash with optic sensor. With this function, the flash will fire synchronously when the main flash fires, the same effect as that by the use of wireless triggers. This helps create multiple lighting effects.

S2 Optic Control Unit Setting

In M manual flash mode, press <S1/S2> button so that this flash can also function as an optic S2 secondary flash with optic sensor. This is useful when cameras have pre-flash function. With this function, the flash will ignore a single "pre-flash" from the main flash and will only fire in response to the second, actual flash from the main flash.

Note: 1. S1 and S2 optic control triggering is only available in M manual flash mode.
2. Press function 3 button <S1/S2> to switch between S1/S2 optic control or turn off this function.

Flash Mode – Multi: Stroboscopic Flash

With slow shutter speed in multi flash mode, a rapid series of flashes is fired. It can be used to capture multiple images of a moving subject in a single photograph.

You can set the flash frequency (number of flashes per sec. expressed as Hz), the number of flashes, and the flash output.

1. Press <MODE> mode button so that <Multi> is displayed on the LCD panel.

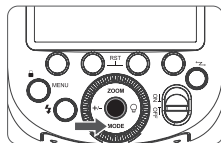

2. Press the function button 2 <Times> to select the number of flashes. Turn the select dial to set the number, then press it to confirm the settings. Press the function button 3 <Hz> to select the flash frequency. Turn the select dial to set the frequency, then press it to confirm the settings.

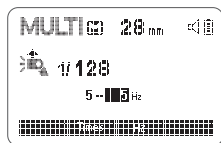

3. Press <+/-> button to select flash output amount. Turn the select dial to set the amount, then press it to confirm the settings.
Flash output range: 1/256-1/4.

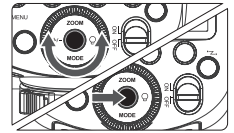

Calculating the Shutter Speed

During multi flash, the shutter remains open until the firing stops. Use the formula below to calculate the shutter speed and set it with the camera.

$$\text{Number of Flashes} / \text{Flash Frequency} = \text{Shutter Speed}$$

For example, if the number of flashes is 10 and the flash frequency is 5Hz, the shutter speed should be at least 2 seconds.

⚠ To avoid overheating and deteriorating the flash head, do not use multi flash more than 10 times in succession. After 10 times, allow the camera flash to rest for at least 15 minutes. If you try to use the multi flash more than 10 times in succession, the firing might stop automatically to protect the flash head. If this happens, allow at least 15 minutes' rest for the camera flash.

Note: 1. Multi flash is most effective with a highly reflective subject against a dark background.
2. Using a tripod and TTL flash trigger XPROII is recommended.
3. A flash output of 1/1 and 1/2 cannot be set for multi flash.
4. Multi flash can also be used with "bulb" mode.
5. Multi flash mode cannot be set in high-speed sync mode.
6. If the number of flashes is displayed as "-,-", the firing will continue until the shutter closes or the battery is exhausted. The number of flashes will be limited as shown by the following table.

Maximum Time of Consecutive Flashes

Flash output \ Hz	1	2	3	4	5	6-7	8-9
1/4	8	6	4	3	3	2	2
1/8	14	14	12	10	8	6	5
1/16	30	30	30	20	20	20	10
1/32	60	60	60	50	50	40	30
1/64	90	90	90	80	80	70	60
1/128	100	100	100	100	100	90	80
1/256	100	100	100	100	100	90	80

Flash output \ Hz	10	11	12-14	15-19	20-50	60-199
1/4	2	2	2	2	2	2
1/8	4	4	4	4	4	4
1/16	10	8	8	8	8	8
1/32	20	20	20	18	16	12
1/64	50	40	40	35	30	20
1/128	70	70	60	50	40	40
1/256	70	70	60	50	40	40

Wireless Flash Shooting: 2.4G Wireless Transmission

This section explains wireless transmitting/receiving flash shooting.

The V1Pro C attached to the camera is referred as the transmitter unit, while a V1Pro C that is wirelessly controlled is referred as the receiver unit.

You can also wirelessly control the V1Pro C set as the receiver unit with the TTL flash trigger XPROII (sold separately). For details on setting the flash trigger functions, see the its instruction manual.

Note: When the camera's shooting mode is set to a fully automatic mode or an image zone mode, the operations in this section are not available. Please set the camera's shooting mode to Fv/P/Tv/Av/M/B.

Using a flash with a radio transmission wireless shooting function make it easy to shoot with advanced wireless multiple flash shooting, in the same way as E-TTL II auto flash shooting.

As long as the channel, group, ID, and other relevant wireless settings of the transmitter and receiver units are set to the same, the settings on the V1Pro C (transmitter unit) will be automatically applied to the wirelessly controlled V1Pro C (receiver unit). Therefore, there is no need to operate the receiver unit during shooting.

Positioning and Operation Range (Example of wireless flash shooting)

• Auto Flash Shooting with One Receiver Unit

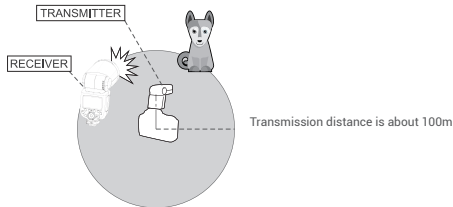

Note: 1. Before shooting, perform a test flash and test shooting.
2. The transmission distance might be shorter depending on the conditions such as positioning of receiver units, the surrounding environment and whether conditions.

Auto Flash Shooting with Multiple Receiver Groups

You can divide the receiver units into two or three groups and perform E-TTL II auto flash while changing the flash ratio (flash output ratio). In addition, you can set and shoot with a different flash mode for each firing group, for up to 4 groups.

• Auto Flash Shooting with Two Receiver Groups

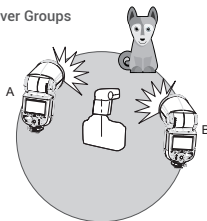

• Auto Flash Shooting with Three Receiver Groups

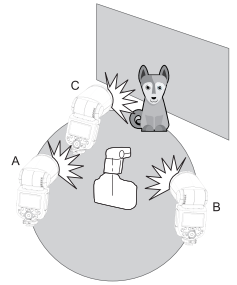

• Shooting with a Different Flash Mode Set for Each Group

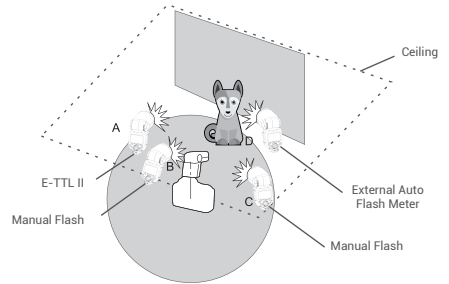

Wireless Settings

You can switch between normal flash and wireless flash. For normal flash shooting, be sure to set the wireless setting to "OFF", and the <☺> won't be displayed on the LCD panel.

Setting the Flash as A Transmitter Unit

Press <Z> button so that <☺> is displayed on the LCD panel, but the <RX> won't be displayed.

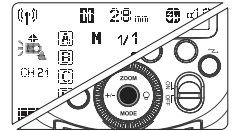

Setting the Flash as A Receiver Unit

Press <Z> button so that <☺> and <RX> are displayed on the LCD panel.

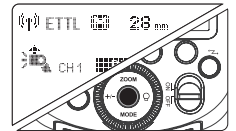

Wireless Channel Settings

If there are other wireless flash systems nearby, you can change the wireless channels to prevent signal interference. The wireless channels of the transmitter unit and the receiver unit(s) must be set to the same.

1. Press **-MENU-** menu button to enter menu setting. Turn the select dial to **<CH>**, then press the set button to choose CH.

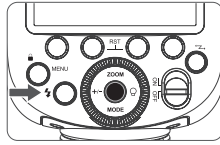

2. Turn the select dial to adjust wireless channel from 01 to 32. Press the set button to confirm.

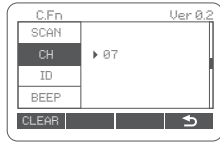

ID Settings

Change the wireless channels and wireless ID to avoid interference for it can only be triggered after the wireless channels and IDs of the transmitter unit and the receiver unit are set to the same. Press the menu button to enter C.Fn ID, press the set button to choose OFF to turn off the wireless ID, or choose any figure from 01 to 99.

1. Press **-MENU-** menu button to enter menu setting. Turn the select dial to **<ID>**, then press the set button to choose ID.

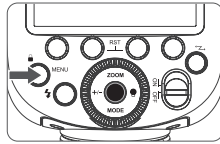

2. Turn the select dial to adjust wireless ID from 01 to 99 or OFF. Press the set button to confirm.

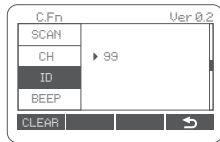

Scan the Spare Channel

You can scan the spare channel to avoid the interference of using the same channel by others.

1. Press **-MENU-** menu button to enter menu setting. Turn the select dial to **<SCAN>**, then press the set button to choose SCAN.

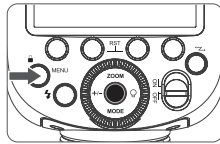

2. Turn the select dial to choose START, then press the set button to scan. And the 8 spare channels will be displayed for your choice.

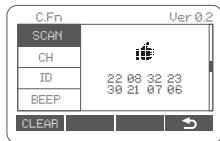

Transmitter Unit's (Flash) ON/OFF

You can set whether the transmitter unit (flash) that transmits wireless signal flashes or not, and when the transmitter unit flash setting is on, the flash fires as a flash A group.

1. Press **-MENU-** menu button to enter menu setting. Turn the select dial to **<TX>**, then press the set button to choose TX.

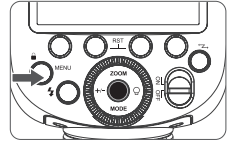

2. Turn the select dial to choose **<A>** or ****. Press the set button to confirm. **<A>**: The transmitter unit flash firing is OFF. ****: The transmitter unit flash firing is ON.

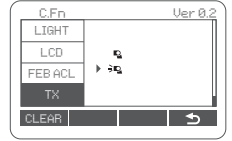

Note: Even if the transmitter unit flash firing is off, it still transmits wireless flash signals.

ETTL: Fully Automatic Wireless Flash Shooting

Using Automatic Wireless Flash with a Single Receiver Unit

1. Transmitter Unit Setting

Press the wireless button and the **<TX>** icon is displayed on the LCD panel, then the V1 Pro C attached to the camera is set as the transmitter unit.

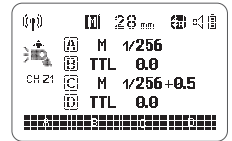

X2T-C can also be set as transmitter unit. X2T-C can control V1 Pro C's ZOOM value when the ZOOM is adjusted to auto (A) mode.

2. Receiver Unit Setting

Press the wireless button and the **<RX>** is displayed on the LCD panel, then the V1 Pro C wirelessly controlled is set as the receiver unit.



3. Check the Communication Channel

Set the wireless channels of transmitter unit and receiver unit to the same. For example, if the transmitter unit channel is set to 01, then the receiver unit channel needs to be 01 as well.

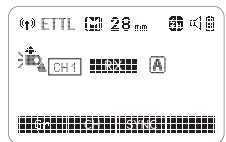
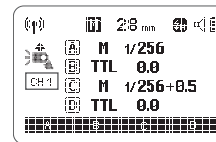

4. Position the Camera and Flashes

The transmission distance of the transmitter unit and receiver unit is about 100m.

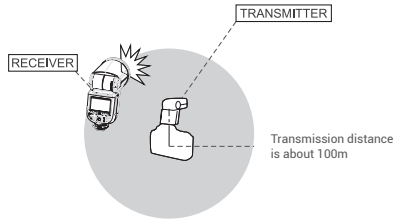

- Note:
1. Press the depth-of-field preview button on the camera to fire a modeling flash.
 2. If the receiver unit's auto power off function is on, press the transmitter unit's test button to power it on. Please note that test firing is unavailable during the camera's regular metering time.
 3. By pressing the menu button to enter C.Fn setting, the effective time of receiver unit's auto power off is changeable between 60min or 30min (RX STBY).

5. Set the Flash Mode to <ETTL>

Press the corresponding function button 1/2/3/4<A/B/C/D > to make <TTL> is displayed on the LCD panel. The receiver unit controlled by the transmitter unit will automatically be set as <TTL>.

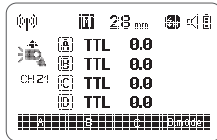

Please set the MENU-TX transmitter unit's flash to ON in order to make the transmitter unit fire flashes.

Using Fully Automatic Wireless Flash

The FEC and other settings that set on the transmitter unit will also be appeared on the receiver unit automatically. The receiver unit does not need any operation. Use the following settings to make wireless flash shooting according to the same methods with normal flash shooting.

- Flash Exposure Compensation
- Flash Exposure Lock

About Transmitter Unit

Use two or more transmitter units. By preparing several cameras that with transmitter units attached, cameras can be changed in shooting while keeping the same lighting source (receiver unit).

6. Check Whether the Flash is Ready

Check whether the transmitter unit's flash ready indicator is lightened. When the receiver unit's flash is ready, the AF-assist beam lighting area will blinks at 1 second intervals.

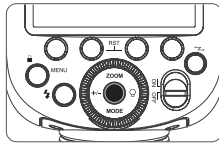

7. Check the Flash Operation

Press the transmitter unit's test button <T>. Then, the receiver unit will fire. If not, adjust the distance from the transmitter unit.

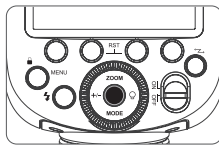

M: Wireless Flash Shooting with Manual Flash

Using wireless (multiple flash) shooting with manual flash, you can shoot with a different flash output setting for each receiver unit (flash group) while setting all parameters on the transmitter unit.

1. Set the Transmitter Unit's Flash Group to <M>

Press the wireless button and the <M> icon is displayed on the LCD panel, then the V1 Pro C attached to the camera is set as the transmitter unit. Press the corresponding function button 1/2/3/4<A/B/C/D > to make <M> is displayed in all the flash groups on the LCD panel.

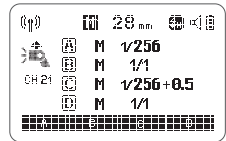

2. Set the Flash Output of Each Flash Group

Press function button <A/B/C/D > to choose a group. Turn the select dial to set the flash output of the group, then press the set button to confirm.

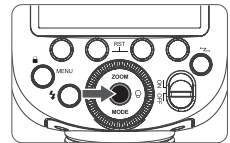

3. Set the Wireless Channels of Transmitter Unit and Receiver Unit to the Same

For example, if the transmitter unit channel is set to 01, then the receiver unit channel needs to be 01 as well.

4. Take Picture

Each receiver unit fires at the set flash ratio.

Using Automatic Wireless Flash with Multiple Receiver Units

When stronger flash output or more convenient lighting operation is needed, increase the number of receiver units and set it as a single receiver unit. To add receiver units, use the same steps as setting "using automatic wireless flash with a single receiver unit". Any flash group can be set (A/B/C/D/E).

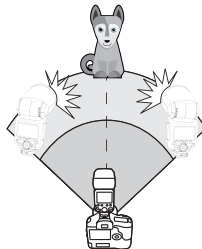

When the number of receiver units is increased or the transmitter unit flash firing is ON, automatic control is implemented to make all groups of flashes fire the same flash output and ensure the total flash output is up to standard exposure.

Multi: Wireless Flash Shooting with Manual Flash

1. Set the Transmitter Unit to Wireless Multi Flash

Press <MODE> mode button so that <Multi> is displayed on the LCD display, then press the wireless button so that <Multi> and <Ⓜ> are displayed on the LCD display at the same time.

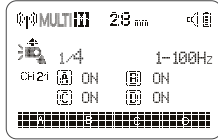

2. Set the Flash Output, Number of Flashes and Flash Frequency of the Wireless Multi Flash

Press <+/-> button to select flash output of multi flash. Turn the select dial to set the flash output amount, then press the set button to confirm the settings and exit. Press the set button to select number of flashes of flash frequency. Turn the select dial to set the number of flashes of flash frequency, then press the set button to confirm the settings and exit.

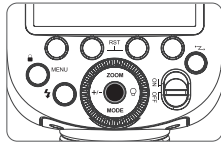

3. Turn On/Off the Wireless Multi Flash of Receiver Unit Group

The wireless multi flash of receiver unit A/B/C/D can be turned on or off directly on the transmitter unit.

4. Set the Receiver Unit

Press the wireless button to make the <RX> is displayed on the LCD panel of the receiver unit.

5. Set the Wireless Channels of Transmitter Unit and Receiver Unit to the Same

For example, if the transmitter unit channel is set to 01, then the receiver unit channel needs to be 01 as well.

Note: The parameters of receiver unit can be directly set on the transmitter unit on the condition that channels and IDs of them are set to the same.

TTL/M Mode Switch Function

1. Toggle the TTL/M mode toggle switch in non-wireless mode can switch flash mode.
2. TCM switch function is workable by default when switched to M manual mode from TTL mode.

Locking Function

Press and hold the <Ⓜ> button for 2s can lock or unlock the screen, "LOCKED" is displayed on the LCD panel when the screen is locked.

The Reason & Solution of Not Triggering in Godox 2.4G Wireless

1. **Disturbed by the 2.4G signal in outer environment (e.g. wireless base station, 2.4G wifi router, Bluetooth, etc.)**
→ To adjust the channel CH setting on the flash trigger (add 10+ channels) and use the channel which is not disturbed. Or turn off the other 2.4G equipment in working.
2. **Please make sure that whether the flash has finished its recycle or caught up with the continuous shooting speed or not (the flash ready indicator is lightened) and the flash is not under the state of over-heat protection or other abnormal situations.**
→ Please downgrade the flash power output. If the flash is in TTL mode, please try to change it to M mode (a pre-flash is needed in TTL mode).
3. **Whether the distance between the flash trigger and the flash is too close or not (< 0.5m).**
→ Please turn on the "close distance wireless mode":
X1 Series: Press and hold the triggering button then turn on the device until the indicator blinks twice.
Xpro and X2T Series: Set the C.Fn-DIST to 0-30m.
X3 Series: Set the trigger distance to 0-30m.
4. **Whether the flash trigger and the receiver end equipment are in the low battery states or not**
→ Please replace the battery.

Other Applications

Sync Triggering

The sync cord jack is a Φ 2.5mm plug. Insert a trigger plug here and the flash will be fired synchronously with the camera shutter.

Modeling Flash

If the camera has a depth-of-field preview button, pressing it will fire the flash continuously for 1 second. This is called modeling flash. It enables you to see the shadow effects on the subject and the lighting balance. You can fire the modeling flash during wireless or normal flash shooting.

Note: 1. To avoid overheating and deteriorating the flash head, do not fire the modeling flash for more than 10 consecutive times. If you fire the modeling flash 10 consecutive times, allow at least 10 minutes' break for the camera flash.
2. The modeling flash cannot be fired with the EOS 300 and Type-B cameras.

Auto Focus Assist Beam

In poorly-lit or low-contrast shooting environments, the built-in auto focus assist beam will automatically light on to make it easier for autofocus. The beam will light up only when autofocus is difficult and get out as soon as the autofocus becomes correct.

If you want to turn off the auto focus assist beam, set the "AF" to "OFF" in the C.Fn settings.

Note: If you find the auto focus assist beam does not light up, this is because the camera has got a correct autofocus.

Position	Effective Range
Center	0.6~10m / 2.0~32.8 feet
Periphery	0.6~5m / 2.0~16.4 feet

Bounce Flash

By pointing the flash head toward a wall or ceiling, the flash will bounce off the surface before illuminating the subject. This can soften shadows behind the subject for a more natural-looking shot. This is called bounce flash.

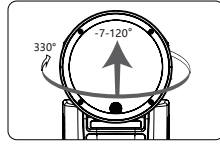

To set the bounce direction, hold the flash head and turn it to a satisfying angle.

Note: 1. If the wall or ceiling is too far away, the bounced flash might be too weak and result in underexposure.
2. The wall or ceiling should be a plain, white color for high reflectance. If the bounce surface is not white, a color cast may appear in the picture.

ZOOM: Setting the Flash Coverage

The flash coverage can be set automatically or manually. It can be set to match the lens focal length from 28mm to 105mm. In auto zoom mode, the focal length changes in response to the camera's zoom lens to provide optimal flash results.

In manual zoom mode, press the <ZOOM> button.

- Turn the select dial to change the flash coverage.
- If <A> is displayed, the flash coverage will be set automatically.

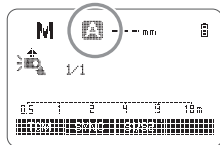

Note: If you set the flash coverage manually, make sure it covers the lens focal length so that the picture will not have a dark periphery.

Low Battery Warning

If the battery power is low, a battery icon will appear and blink on the LCD panel. Please replace the battery immediately.

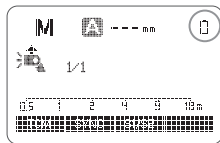

C.Fn: Setting Custom Functions

Press the menu button to enter C.Fn settings.

Custom Function Signs	Function	Options	Settings & Description
m/ft	Distance indicator	m ft	m Feet
AF	AF-assist beam	ON OFF	ON OFF
STBY	Auto sleep setting	ON OFF	ON OFF
RX STBY	Receiver auto power off timer	60min 30min	Power off automatically after 60 minutes of idle use when the flash is set as a receiver unit. Power off automatically after 30 minutes of idle use when the flash is set as a receiver unit.
SCAN	Scan the spare channel	OFF START	OFF Start to scan the spare channel
CH	Wireless Channel	01-32	Choose channels from 01-32
ID	ID	OFF 01-99	OFF Choose any figure from 01-99
BEEP	Beeper	ON OFF	ON OFF
LIGHT	Backlighting time	12sec OFF ON	Off in 12 sec. Always off Always lighting
LCD	LCD contrast ratio	-3~+3	7 levels
FEB ACL	FEB auto cancel	ON OFF	ON OFF
TX	Transmitter unit control	OFF ON	OFF ON

Note: 1. The "Ver.x" in the top-right corner refers to the software version.
2. Turn the select dial to select the custom function No. and its parameters.
3. Press set button to select the custom function No. and confirm its setting.
4. After you set the custom function and press <MENU> menu button, the camera will be ready to shoot.
5. Press and hold the function button 1 <CLEAR> in the MENU interface until "OK" is displayed on the panel, which means the parameters in C.Fn are reset.

Control with the Camera's Menu

If the camera flash is attached to an EOS camera which has a camera control function, the flash can be controlled using the camera's menu screen. For the menu operation procedure, refer to your camera's instruction manual.

• Setting Camera Flash Functions

The following flash functions are settable according to different flash modes.

1. Flash mode
2. Shutter sync
3. FEB
4. Flash exposure compensation
5. Flash firing
6. Clear camera flash's settings

- Custom Functions of Camera Flash

C.Fn-00, C.Fn-01, C.Fn-03, C.Fn-08, C.Fn-10, C.Fn-20, C.Fn-22.

Clear All Flash Custom Functions

Flash function settings screen

Flash function settings	
Flash mode	E-TTL II
Shutter sync	1st curtain
FEB	-3.2, 1.0, 1.2, 3
FEC	-3.2, 1.0, 1.2, 3
E-TTL II	Evaluative
Flash firing	Enable
Clear Speedlite Settings	

Flash C.Fn settings screen

Flash C.Fn settings	
Auto power off	1
0: Enabled	
1: Disabled	
0 1 2 3 4 5 6 7 8 9 10 11 12 13	
0 0 0 0 0 0 0 0 0 0 0 0 0 0	

* Screens from the EOS-1D Mark III.

Note: 1. If flash exposure compensation has already been set with the camera flash, flash exposure compensation cannot be set with the camera. To set it with the camera, the camera flash's flash exposure compensation must be set to zero.
2. If any flash custom functions and flash settings other than flash exposure compensation have been set by both the camera and the flash, the latest settings will take effect.

Protection Function

1. Over-Temperature Protection

- To avoid overheating and deteriorating the flash head, do not fire more than 100 continuous flashes in fast succession at 1/1 full power. After 100 continuous flashes, allow a rest time of at least 10 minutes.
- If you fire more than 100 continuous flashes and then fire more flashes in short intervals, the inner over-temperature protection function may be activated and make the recycle time over 10 seconds. If this occurs, allow a rest time of about 10 minutes, and the flash unit will then return to normal.
- When the over-temperature protection is started, \llcorner is shown on the LCD display.

Number of flashes that will activate over-temperature protection:

Power Output Level	Number of Flashes
1/1	100
1/2 (+0.1~+0.9)	150
1/4(+0.1~+0.9)	300
1/8(+0.1~+0.9)	300
1/16(+0.1~+0.9)	1100
1/32(+0.1~+0.9)	3500
1/64(+0.1~+0.9)	3500
1/128(+0.1~+0.9)	3500
1/256(+0.1~+0.9)	3500

Note: Numbers of flashes of over-temperature protection are different in different zoom values and different levels.

Number of flashes that will activate over-temperature protection in HSS mode:

Power Output Level	Number of Flashes
1/1	60
1/2 (+0.1~+0.9)	70
1/4(+0.1~+0.9)	100
1/8(+0.1~+0.9)	100
1/16(+0.1~+0.9)	100
1/32(+0.1~+0.9)	100
1/64(+0.1~+0.9)	100
1/128(+0.1~+0.9)	100
1/256(+0.1~+0.9)	100

Technical Data

Model	V1Pro C
Compatible Cameras	Canon EOS cameras (E-TTL II auto flash)
Power(1/1output)	76Ws
Flash Coverage	28 to 105mm • Auto zoom (flash coverage is set automatically to match the lens focal length and image size) • Manual zoom • Swinging/tilting flash head (bounce flash): 0 to 330° horizontally and -7° to 120° vertically
Flash Duration	1/300 to 1/20000 seconds
Exposure Control	
Exposure Control System	E-TTL II auto flash and manual flash
Flash Exposure Compensation (FEC)	Manual, FEB: ± 3 steps with 1/3 increment each step (Manual FEC and FEB can be combined)
Flash Exposure Lock (FEL)	With \llcorner button or \llcorner button
Sync Mode	High-speed sync (up to 1/8000 seconds), first-curtain sync, and second-curtain sync
Multi Flash	Provided (up to 100 times, 199Hz)
Wireless Flash (Radio 2.4G Transmission)	
Wireless Function	Transmitter, Receiver, Off
Transmitter Unit Groups	A, B, C, D
Controllable Receiver Groups	A, B, C, D, E (E group can be controlled by X series flash trigger)
Transmission Range (approx.)	100m
Channels	32 (01~32)
ID	OFF/01~99
Modeling Flash	Fired with camera's depth-of-field preview button
Auto Focus Assist Beam	
Effective Range (approx.)	Center: 0.6~10m / 2.0~32.8 feet Periphery: 0.6~5m / 2.0~16.4 feet
LED Modeling Lamp	
Power	2w
Color Temperature	3300K \pm 200K
Power Supply	
Built-in Lithium Battery	7.2V/2980mAh
Recycle Time	Approx. 1.3 seconds. Green LED indicator will light up when the flash is ready.
Number of Flashes at 1/1 step	Approx. 500



Power Saving	Power off automatically after approx. 90s of idle use when set as a transmitter unit. Screen sleep automatically after approx. 60min (or 30min) of idle use when set as a receiver unit.
Sync Triggering Mode	Hot shoe, 2.5mm sync cord
Dimension	
W x H x D	6.14"x2.99"x4.88"
Net Weight Without Battery	466g
Net Weight With Battery	580g

Specifications and data may be subject to changes without notice.

Troubleshooting

If there is a problem, refer to this troubleshooting guide.

The camera flash does not fire.

- The camera flash is not attached securely to the camera.
Attach the camera's mounting foot securely to the camera.
- The electrical contacts of the camera flash and camera are dirty.
→ Clean the contacts..
-  is not displayed in the view finder of camera.
→ Wait until the flash is fully recycled and the flash ready indicator lights up.
→ If the flash ready indicator lights up, but  is not displayed in the view finder, check whether this flash unit is securely attached to the camera hot shoe.
→ If the flash ready indicator does not light up after a long wait, check whether the battery power is enough. If the battery power is low,  will appear and blink on the LCD panel. Please replace the battery immediately.

The power turns off by itself.

- After 90 seconds of idle operation, auto power off took effect if the flash is set as a transmitter unit.
→ Press the shutter button halfway or press any flash button to wake up.
- After 60 minutes (or 30 minutes) of idle operation, the flash enter sleep mode if it is set as receiver unit.
→ Press any flash button to wake up.

Auto zoom does not work.

- The camera flash is not attached securely to the camera.
→ Attach the camera flash's mounting foot to the camera.

The flash exposure is underexposed or overexposed.

- There was a highly reflective object (e.g. glass window) in the picture.
→ Use FE lock (FEL).
- You used high-speed sync.
→ With high-speed sync, the effective flash range will be shorter. Make sure the subject is within the effective flash range displayed.
- You used manual flash mode.
→ Set the flash mode to E TTL or modify the flash output.

Photos have dark corners or only parts of the target subject are illuminated.

- The focal length of lens exceeds the flash coverage.
→ Check the flash coverage you set. This flash unit has the flash coverage between 28 and 105mm, which fits medium-format cameras.

Firmware Upgrade

- This product supports firmware upgrade through the USB-C port, please use USB-C cable (sold separately).
- As the firmware upgrade needs the support of Godox G3 software, please download and install the "Godox G3 firmware upgrade software" before upgrading. Then, choose the related firmware file.
- Please refer to the latest electronic version of the instruction manual.

Compatible Camera Models

This flash unit can be used on the following Canon EOS series camera models:

1DX, 5D Mark III, 5D Mark II, 6D, 7D, 60D, 50D, 40D, 30D, 650D, 600D, 550D, 500D, 450D, 400D Digital, 1100D, 1000D, 5D Mark IV, 7D Mark II, 6D Mark II, 760D, 750D, 70D, 80D, 800D, 77D, M5, M3, M50, EOS R, 1500D, 3000D, 5D II, 5D III, RP, 90D

Note: 1. This table only lists the tested camera models, not all Canon EOS series cameras.
For the compatibility of other camera models, a self-test is recommended.
2. Rights to modify this table are retained.

Maintenance

- Shut down the device immediately should abnormal operation be detected.
- Avoid sudden impacts and the product should be dedusted regularly.
- It is normal for the flash tube to be warm when in use. Avoid continuous flashes if unnecessary.
- Maintenance of the flash must be performed by our authorized maintenance department which can provide original accessories.
- This product, except consumables e.g. flash tube, is supported with a one-year warranty.
- Unauthorized service will void the warranty.
- If the product had failures or was wetted, do not use it until it is repaired by professionals.
- Changes made to the specifications or designs may not be reflected in this manual.

FCC Statement

This device complies with part 15 of the FCC Rules. Operation is subject to the following two conditions: (1) This device may not cause harmful interference, and (2) this device must accept any interference received, including interference that may cause undesired operation.
Any Changes or modifications not expressly approved by the party responsible for compliance could void the user's authority to operate the equipment.

Note: This equipment has been tested and found to comply with the limits for a Class B digital device, pursuant to part 15 of the FCC Rules. These limits are designed to provide reasonable protection against harmful interference in a residential installation. This equipment generates uses and can radiate radio frequency energy and, if not installed and used in accordance with the instructions, may cause harmful interference to radio communications. However, there is no guarantee that interference will not occur in a particular installation. If this equipment does cause harmful interference to radio or television reception, which can be determined by turning the equipment off and on, the user is encouraged to try to correct the interference by one or more of the following measures:

- Reorient or relocate the receiving antenna.
- Increase the separation between the equipment and receiver.
- Connect the equipment into an outlet on a circuit different from that to which the receiver is connected.
- Consult the dealer or an experienced radio/TV technician for help.

The device has been evaluated to meet general RF exposure requirement.
The device can be used in portable exposure condition without restriction.

Warning

Operating frequency:2403MHz-2483.0MHz
Maximum EIRP Power: -10.82dBm

Declaration of Conformity
GODOX Photo Equipment Co.,Ltd. hereby declares that this equipment are in compliance with the essential requirements and other relevant provisions of Directive 2014/53/EU. In accordance with Article 10(2) and Article 10(10), this product is allowed to be used in all EU member states.

For more information of DoC, Please click this web link:
<https://www.godox.com/eu-declaration-of-conformity/>
The device complies with RF specifications when the device used at 0mm from your body.

产品保修

尊敬的用户，本保修卡是申请保修服务的重要凭证，请您配合销售商填写并妥善保管，谢谢！

产品信息	型号	产品条码
用户信息	姓名	联系电话
	通信地址	
销售商信息	名称	
	联系电话	
	通信地址	
	销售日期	
备注		

注：此表应由销售商盖章确认。

适用范围

本文件适用于相关《产品保修资讯》（见后面说明）所列产品，其他非属此范围的产品或部件（如促销品、赠品及其他出厂后附加的部件等）不在此保修承诺内。

保修期

产品及部件的相应保修期按相关的产品保修信息执行。保修期自产品首次购买日起算，购买日以购买产品时保修卡登记日期为准。

如何获得保修服务

您可直接与产品销售商或授权服务机构联系，也可拨打神牛产品售后服务电话，与我们联系，由我们的服务人员为您安排服务。申请保修时，您应提供有效的保修卡作为保修凭证，方可获得保修。如您不能提供有效的保修卡，则在我们确认产品或部件属于保修范围的情况下，也可以为您提供保修，但这不作为我们的义务。

不适用保修的情况

如产品存在下列情况，本文件项下的保证和服务将不适用：①产品或部件超过相应保修期；②错误或不当使用、维护或保管导致的故障或损坏，如：不当搬运；非按产品合理预期用途使用；不当插拔外接设备；跌落或外力挤压；接触或暴露于不适当温度、溶剂、酸碱、水浸或潮湿环境；③由非神牛授权机构或人员安装、修理、更改、添加或拆卸造成的故障或损坏；④产品或部件原有识别信息被修改变更或删除；⑤无有效保修卡；⑥使用非合法授权、非标准或非公开发行的软件造成的故障或损坏；⑦因不可抗力或意外事件造成的故障或损坏；⑧其他非因产品本身质量问题导致的故障或损坏。遇上述情况，您应向相关责任方寻求解决，神牛对此不承担任何责任。因非在保修期或保修范围内的部件、附件或软件导致产品不能正常使用的，不是保修范围内的故障。产品使用过程中正常的脱色，磨损和消耗，不是保修范围内的故障。

产品保修和服务支持信息

产品的保修期和服务类型按以下《产品保修信息》执行：

产品类别	选件名称	保修期(月)	保修服务类型
部件	主机	12	客户送修
	电池	3	客户送修
	充电器等带电性能的部件。	12	客户送修
其他	如电源线、同步线、外壳、保护罩、锁紧装置、包装等。	无	无保修

神牛产品售后服务电话：0755-29609320-8062

Warranty

Dear customers, as this warranty card is an important certificate to apply for our maintenance service, please fill in the following form in coordination with the seller and safe-keep it. Thank you!

Product Information	Model	Product Code Number
Customer Information	Name	Contact Number
	Address	
Seller Information	Name	
	Contact Number	
	Address	
	Date of Sale	
Note		

Note: This form shall be sealed by the seller.

Applicable Products

The document applies to the products listed on the Product Maintenance Information (see below for further information). Other products or accessories (e.g. promotional items, giveaways and additional accessories attached, etc.) are not included in this warranty scope.

Warranty Period

The warranty period of products and accessories is implemented according to the relevant Product Maintenance Information. The warranty period is calculated from the day (purchase date) when the product is bought for the first time. And the purchase date is considered as the date registered on the warranty card when buying the product.

How to Get the Maintenance Service

If maintenance service is needed, you can directly contact the product distributor or authorized service institutions. You can also contact the Godox after-sale service call and we will offer you service. When applying for maintenance service, you should provide valid warranty card. If you cannot provide valid warranty card, we may offer you maintenance service once confirmed that the product or accessory is involved in the maintenance scope, but that shall not be considered as our obligation.

Inapplicable Cases

The guarantee and service offered by this document are not applicable in the following cases: ① The product or accessory has expired its warranty period; ② Breakage or damage caused by inappropriate usage, maintenance or preservation, such as improper packing, improper usage, improper plugging in/out external equipment, falling off or squeezing by external force, contacting or exposing to the improper temperature, solvent, acid, base, flooding and damp environments, etc; ③ Breakage or damage caused by non-authorized institution or staff in the process of installation, maintenance, alternation, addition and detachment; ④ The original identifying information of product or accessory is modified, alternated, or removed; ⑤ No valid warranty card; ⑥ Breakage or damage caused by using illegally authorized, nonstandard or non-public released software; ⑦ Breakage or damage caused by force majeure or accident; ⑧ Breakage or damage that could not be attributed to the product itself. Once met these situations above, you should seek solutions from the related responsible parties and Godox assumes no responsibility. The damage caused by parts, accessories and software that beyond the warranty period or scope is not included in our maintenance scope. The normal discoloration, abrasion and consumption are not the breakage within the maintenance scope.

Maintenance and Service Support Information

The warranty period and service types of products are implemented according to the following Product Maintenance Information:

Product Type	Name	Maintenance Period(month)	Warranty Service Type
Parts	Circuit board	12	Customer sends the product to designated site
	Battery	3	Customer sends the product to designated site
	Electrical parts e.g. battery charger, etc.	12	Customer sends the product to designated site
Other Items	Power cord, sync cable, lamp body, lamp cover, locking device, package, etc.	No	Without warranty

Godox After-sale Service Call +86-755-29609320(8062)