

Godox

变焦RGB LED摄影灯
Zoom RGB LED Video Light

SZ150R

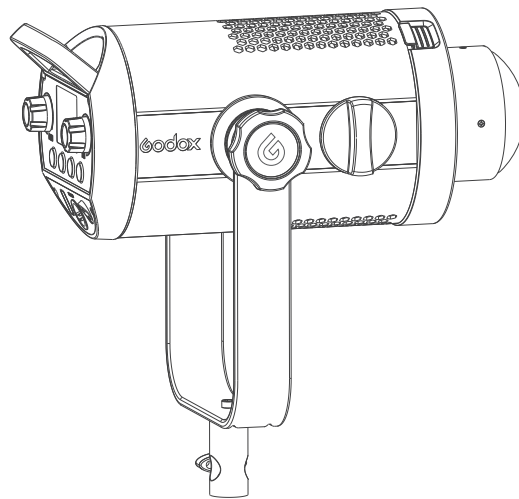

深圳市神牛摄影器材有限公司

地址: 深圳市宝安区福海街道塘尾社区耀川工业区厂房2栋
电话: 0755-29609320(8062) 传真: 0755-25723423 邮箱: godox@godox.com

GODOX Photo Equipment Co., Ltd.

Add: Building 2, Yaochuan Industrial Zone, Tangwei Community, Fuhai Street, Bao'an District,
Shenzhen, China Tel: +86-755-29609320(8062) Fax: +86-755-25723423 E-mail: godox@godox.com

godox.com

Made in China



使用手册
Instruction Manual

Foreword

Thank you for purchasing this Godox Product!

This Zoom RGB LED Video Light SZ150R is a RGB continuous light with multiple functions. Freely switch LED bicolor mode, colorful light mode and 37 situational special effects modes. Suitable for almost all shooting occasions e.g. live, camping, portrait shooting, make up, video, wedding, children photography, etc. It's portable and easy to be operated.

Features:

- Freely switch LED bicolor mode, colorful light mode and 37 situational special effects modes
- Easy to adjust color temperature, light brightness, hue and color saturation
- Combined control by smartphone APP/2.4G wireless/DMX control
- Without noise and interference in silent mode
- Offer strong light in light burst mode
- Manually zooming from 20° to 65°
- With a colored display to clearly show the parameters
- Excellent heat dissipation system

⚠ Warning

- ⚠ Always keep this product dry. Do not use in rain or in damp conditions.
- ⚠ Do not disassemble. Should repairs become necessary, this product must be sent to an authorized maintenance center.
- ⚠ Keep out of reach of children.
- ⚠ As this product do not have waterproof function, please take measures of waterproof in rainy or damp environment.
- ⚠ As this product may heat up in working, please do not touch.

Name of Body

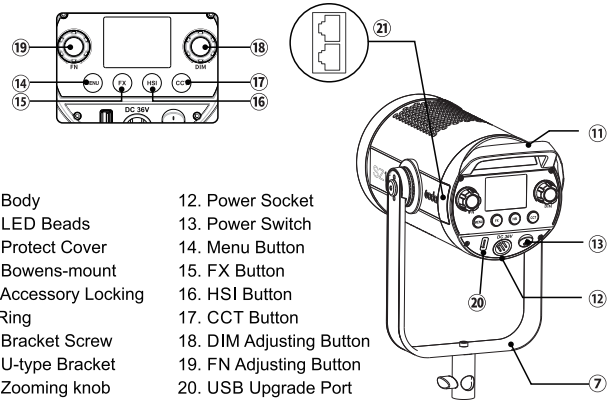
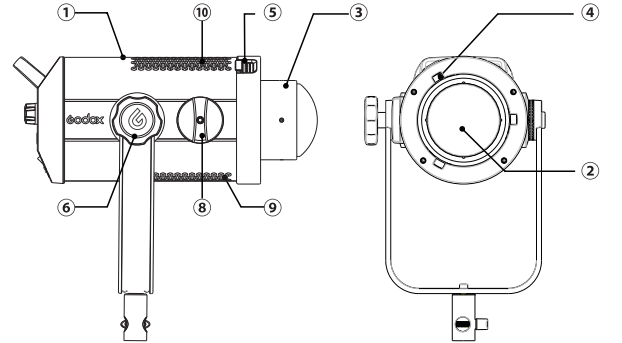

- | | |
|----------------------------|--------------------------|
| 01. Body | 12. Power Socket |
| 02. LED Beads | 13. Power Switch |
| 03. Protect Cover | 14. Menu Button |
| 04. Bowens-mount | 15. FX Button |
| 05. Accessory Locking Ring | 16. HSI Button |
| 06. Bracket Screw | 17. CCT Button |
| 07. U-type Bracket | 18. DIM Adjusting Button |
| 08. Zooming knob | 19. FN Adjusting Button |
| 09. Fan Inlet | 20. USB Upgrade Port |
| 10. Thermovent | 21. RJ45 Port x2 |
| 11. Handle | |

LCD Panel

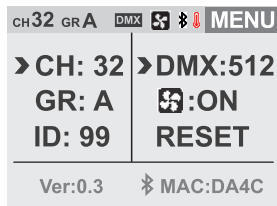

• Menu Interface

1. CH Chanel
2. GR Group
3. 2.4G Wireless ID
4. DMX Channel
5. Fan Switch
6. Bluetooth Password Reset Function
7. V0.3 (Software Version)
8. MAC(Bluetooth number)

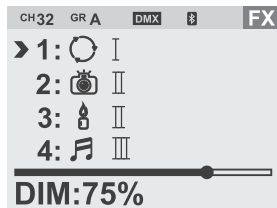

• FX Interface

1. Different Function Display from 13 categories which are divided into 39 kinds
2. DIM: Brightness Display

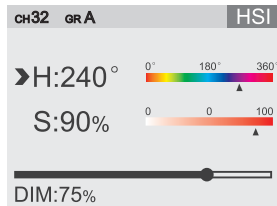

• HSI Interface

1. H: Hue
2. S: Saturation
3. DIM: Brightness Display

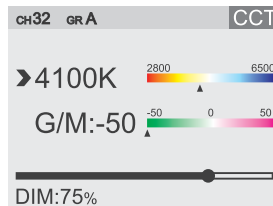

• CCT Interface

1. 2800K~6500K: Color Temperature
2. G/M: Hue
3. DIM: Brightness Display

Included Items

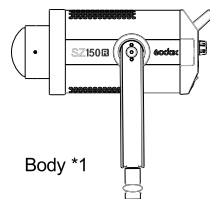

Body *1

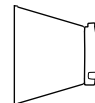

Reflector *1



Protect Cover *1



Steel Cable *1



LSA-18 Power Adapter Holder *1



Clip *1



Adapter *1



Power Cable *1



Instruction Manual *1



Portable Bag *1

Optional Accessory

The product can be used in combination with the following optional accessories so as to achieve best photography effects:

RC-R9 Remote control, inverter, softbox, umbrella, light stand, honey comb, beauty dish, snoot, etc.

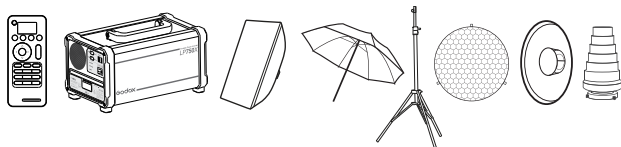

Power Supply

Connect the SZ150R to power source with adapter and power cable. Press the power switch to turn on the LED light.

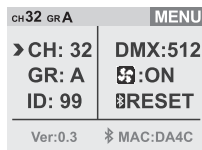
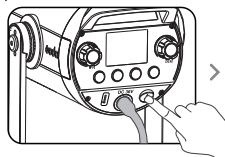

Operation

1. Setting

• Menu Button

Press the MENU button and the LED light will enter menu interface. In this interface, CH channel (1 to 32), GR group (A/B/C/D/E/F,0-9), ID (OFF/01 to 99), DMX function (OFF/001 to 512), Fan (OFF/ON) and Bluetooth can be set.

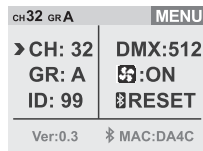

• FX Button

1. Press the FX button and the LED light will enter FX interface. In this interface, you can set 37 different special effects which are divided into 13 categories according to your demands.

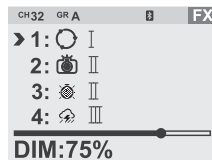

No.	Display	Situation	Display I	Display II	Display III
1		RGB cycle	Slow speed	Medium speed	Quick speed
2		Flash	Flash	Press conference	Paparazzi
3		Laser	Birthday party	KTV	Disco
4		Lightning	Discontinuous	Frequent	Sustainable
5		Broken bulb	Discontinuous	Frequent	Sustainable
6		TV	Slow speed	Medium speed	Quick speed
7		Candle	Discontinuous	Frequent	Sustainable
8		Fire	Firewood	Campfire	Fire hazard
9		Firework	Brief	Continuous	Show
10		Police car	Strong flash	Frequent flash	Quick flash
11		Fire truck	Strong flash	Frequent flash	Quick flash
12		Ambulance	Strong flash	Frequent flash	Quick flash
13		SOS			

2. In FX mode, turn the FN select dial to choose the special effect modes from 1 to 13 categories. And the modes will be selected circularly by turning the select dial. After choosing the current mode, press down the FN multifunctional select dial from I, II and III. And the modes will display circularly when keeping pressing the FN multifunctional select dial. Turn the DIM select dial to choose brightness from 0% to 100% and the brightness value will be precisely displayed on the LCD panel.

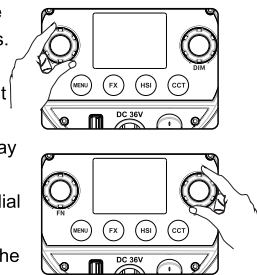

• HSI Button

Press HSI button and the LED light will enter HSI interface.

1. Short press FN button, choose H and turn the FN select dial to adjust H hue from 0° to 360°. Quickly change the parameters by turning the select dial faster.
2. Short press FN button, choose S and turn the FN select dial to adjust S saturation from 0 to 100. Quickly change the parameters by turning the select dial faster.
3. Turn the DIM select dial to adjust light brightness from 0% to 100%. Short press the DIM select dial once to turn off the brightness. Press the button again to recover the brightness set before.

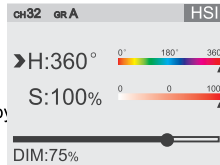

• CCT Button

Press the CCT button to enter color temperature setting interface.

1. Short press the FN button to select the color temperature. Then, turn the FN select dial to adjust color temperature from 2800K to 6500K.
2. Short press the FN button to select G/M. Then, turn the FN select dial to adjust hue from -50 to 50.

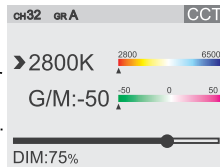

• Zooming Knob

By adjusting this knob, the beam angle can be changed from 20° to 65°.

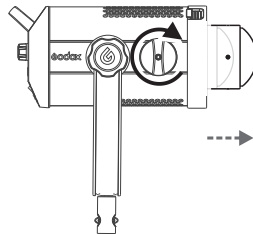

• USB Upgrade Port

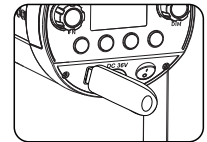

1. Download the new firmware into U disk from official website <http://www.godox.com.cn/Downloads.html>.
2. Turn off the LED light. Insert the U disk with new firmware into the USB upgrade port.
3. Turn on the LED light, and it will automatically enter the upgrading interface.
4. The LED light will automatically back to the main interface.



Note: 1. The newest firmware must be downloaded from the official website and stored in the root directory of U disk. And there can only be one BIN document.

2. The USB port can only support firmware upgrade function.

• Silent Mode

Press the Menu button to enter the MENU interface. Turn the FN select dial to choose  icon. Then, turn the DIM select dial, choose ON to boot the fan. When choosing OFF,  will be displayed and the fan will be turned off to achieve silent mode.

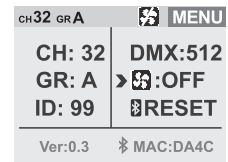

Control Mode Selection

1. DMX Control Setting

In NENU interface, choose DMX options to set DMX channels (OFF/001~512). Connect the LED light to DMX control panel by RJ45 port. Set them to the same channel, the SZ150R can be controlled by control panel.

DMX:OFF

Mode Channel	CCT	HSI	RGBW	FX	Note
n(Mode)	0-51	52-103	104-155	156-255	
n*1	DMX*(100/255) Integer 0-100% Light Brightness	DMX*(100/255) Integer 0-100% Light Brightness	0-255	DMX*(100/255) Integer 0-100% Light Brightness	
n*2	DMX*(Max. Color Temperature - Min. Color Temperature)/100(255)Integer	DMX*(360/255) Integer Hue Selection	0-255 R's Value	DMX*(Total Number of Special Light Effect/255)	1. Color Temperature Adjustment(e.g. min. color temperature 2850, min. color temperature 6500, DMX=102, 102*(6500-2800)/100/255=14)(Corresponding color temperature 28+14*42*100=4200) 2. Hue Adjustment (DMX=200, H=200*360/255=282) 3. For example: total number of special light effect 14, DMX=160, number of special light effect=160*14/255=8
n*3	DMX*(100/255) Integer G/M Setting	DMX*(100/255) Integer Saturation Setting	0-255 G's Value	0-85: I 86-171: II 172-255: III	G/M Adjustment:(50-0-50 Corresponding Value0-50-100) DMX=212,GM Mapped Value=(212*100/255=83) -50=33
n*4			0-255 B's Value		
n*5			0-255 W's Value		

2. 2.4G Wireless Control

With 2.4G wireless system, SZ150R LED video light has remote grouping and control function. It is recommended to purchase RC-R9 remote control(optional) to achieve wireless control. Up to 16 groups of LED lights can be controlled. 32 channels and 99IDs are available with strong anti-interference capability.

Press the MENU button to enter MENU interface and turn the FN select dial: Select CH and turn the DIM select dial to choose channels from 1 to 32. Select GR and turn the DIM select dial to choose groups from A to E and 0 to 9. Select ID and turn the DIM select dial to choose IDs from OFF, 01 to 99.

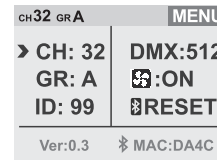

Note:

1. Please make LED light's channel, group and ID to the same as remote control's.
2. The wireless signals can only be received in the situation that the LED light is powered on.

3. Bluetooth Control

3.1 Press the MENU button to enter MENU interface. Turn the FN select dial to choose RESET. Then, short press the FN button to achieve Bluetooth function.

Note: the APP can be used directly on the firstly installed device. When changing to other mobile device, the light shall be reset before the normal usage of APP.

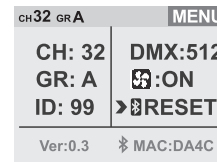

3.2 Scan the QR code to download the "Godox Light" smartphone APP(can be used by Android and Apple system). For more smartphone APP operations, please open the "help" in APP to gain detailed guidance.



Technical Data

LED Light	SZ150R
Power Supply	AC100V-240V(50/60HZ)
Power	150W
Channel	32
Group	16(A, B, C, D, E, F, 0-9)
Color Temperature Range	2800K~ 6500K
Brightness Range	0%-100%
RGB Hue	0~360°
100% Illuminance(LUX) (darkroom, 1m distance with included reflector)	Central point
	Max. diffused light of focal length ≈19000
	Min. diffused light of focal length ≈26000
CRI (≈)	97
TLCI (≈)	96
Working Environment Temperature	-10°C~ 40°C
Special Effects Modes	37
Mode	Bicolor mode/HSI mode/situational mode
Zooming	Beam Angle 20°~ 65°
Control Method	Smartphone APP/2.4G wireless/ DMX intelligent control
Wireless Control Distance	≈50m (with optional remote control RC-R9)
Silent Mode	Yes
Display	Color Display
Dimension	336*198.6*165mm
Net Weight	2.65kg (not include reflector and protect cover)

* Product design and specifications are subject to change without notice.

Maintenance

This product, except consumables e.g. adapter and adapter cable, is supported with a one-year warranty.

Avoid sudden impacts and the product should be dedusted regularly.

Maintenance of the flash must be performed by our authorized maintenance department which can provide original accessories.

Unauthorized service will void the warranty.

If the product had failures or was wetted, do not use it until it is repaired by professionals.

Changes made to the specifications or designs may not be reflected in this manual.

Warning

Operating frequency:2412.99MHz – 2464.49MHz(2.4G only receive)/2402MHz – 2480MHz (BT)
Maximum EIRP Power: -0.83dBm

Declaration of Conformity

GODOX Photo Equipment Co.,Ltd. hereby declares that this equipment are in compliance with the essential requirements and other relevant provisions of Directive 2014/53/EU. In accordance with Article 10(2) and Article 10(10), this product is allowed to be used in all EU member states.For more information of DoC, Please click this web link:*

https://www.godox.com/DOC/Godox_SZ150R_Series_DOC.pdf

The device complies with RF specifications when the device used at 0mm from your body.

FCC Statement

This device complies with part 15 of the FCC Rules. Operation is subject to the following two conditions: (1) This device may not cause harmful interference, and (2) this device must accept any interference received, including interference that may cause undesired operation.

Any Changes or modifications not expressly approved by the party responsible for compliance could void the user's authority to operate the equipment.

Note: This equipment has been tested and found to comply with the limits for a Class B digital device, pursuant to part 15 of the FCC Rules. These limits are designed to provide reasonable protection against harmful interference in a residential installation. This equipment generates uses and can radiate radio frequency energy and, if not installed and used in accordance with the instructions, may cause harmful interference to radio communications. However, there is no guarantee that interference will not occur in a particular installation. If this equipment does cause harmful interference to radio or television reception, which can be determined by turning the equipment off and on, the user is encouraged to try to correct the interference by one or more of the following measures:

- Reorient or relocate the receiving antenna.
- Increase the separation between the equipment and receiver.
- Connect the equipment into an outlet on a circuit different from that to which the receiver is connected.
- Consult the dealer or an experienced radio/TV technician for help.