

合格证
QC PASS



Wechat
Official Account
神牛微信公众号

深圳市神牛摄影器材有限公司

地址：深圳市宝安区福海街道塘尾社区耀川工业园厂房 2 栋
电话：0755-29609320 (8062) 传真：0755-25723423 邮箱：godox@godox.com

GODOX Photo Equipment Co., Ltd.

Add.: Building 2, Yaochuan Industrial ZoneTangwei Community, Fuhai Street, Bao'an District, Shenzhen
518103, China Tel: +86-755-29609320(8062) Fax: +86-755-25723423 E-mail: godox@godox.com

www.godox.com

Made in China | 705-AD60P2-00



Godox

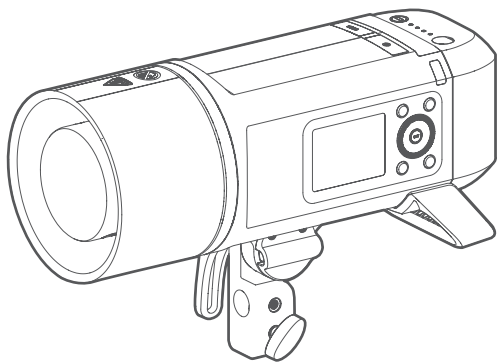

AD600Pro II

一体式外拍闪光灯
All-in-One Outdoor Flash

使用手册
Instruction Manual

说明书安全提示

重要安全提示

本产品属于专业摄影设备,需要专业人员操作使用。使用时必须遵守以下基本安全预防措施:使用前必须拆除产品上的所有运输保护材料和包装。

1. 使用本产品前,请仔细阅读并完全理解产品说明书,严格按照说明书中的安全提示操作。否则,可能导致死亡、严重伤害、产品损坏或其他财产损失的安全隐患。
2. 闪光灯工作时存在高电压,关机后设备内部电容仍将持续带电一段时间。
3. 本产品为专业灯具,儿童禁止使用。儿童接近时,成人必须密切监督,防止儿童碰撞灯具或私自使用灯具,造成人身伤害。
4. 本灯具并非普通灯具,不可用于普通照明,任何有过眼部损伤或眼部敏感的人群均应避免使用本灯具或直视本灯具。
5. 使用时必须小心,严禁接触如闪光管等高温部件,以避免烫伤。
6. 任何情况下均禁止将闪光灯直接对准人眼(特别是婴儿眼睛),否则短时间内可能导致视力损伤。如感到眼睛不适,应立即关闭灯具,停止使用并及时就医。
7. 闪光管损坏时,应立即停止使用,及时联系制造商、服务代理商或合格维修人员更换,以防发生事故。
8. 严禁使用损坏的设备或配件,必须等待专业维修人员检查维修并确认设备正常后,才可继续使用。
9. 更换灯管、保护玻璃或保险丝前,必须断开电源或者拆下电池(如装有电池),确保灯具与电源完全断开。更换灯管前让其冷却10分钟,操作时需戴绝缘/或隔热手套。
10. 拔插灯头插头时必须关闭产品电源,插入插头时务必检查是否完全卡入。
11. 使用过程中,如果产品因跌落、挤压或强力冲击导致外壳破裂,应立即停止使用,避免接触内部电子部件而触电受伤。
12. 部分产品电源线较长,请合理放置,避免接触热源或绊倒他人。建议使用原装电源线。非原装线造成的损坏不在保修范围内。
13. 进行清洁和维修前,请先从电源插座上拔出设备电源插头。不要拉扯电源线强行拔出,正确方法是用双手抓住插头端头拔出。
14. 本设备不防水,请保持干燥,不能浸入水或其他液体;应安装在通风干燥位置,避免在雨天、潮湿、多尘或过热环境中使用。不要在设备上方放置物品,或让液体流入内部,防止发生危险。
15. 未经授权,请不要自行拆卸本产品。产品若出现故障,必须由本公司或授权维修人员检查和维修。
16. 存放设备前,请确保设备已完全冷却,拔下电源线,放入设备包内或通风干燥位置。
17. 请勿将设备放置在酒精、汽油等易燃挥发性溶剂或气体如甲烷、乙烷等附近。
18. 本设备禁止在有爆炸危险的环境中使用或存放。
19. 严禁覆盖设备散热口!
20. 请勿使用未经本公司认可的配件,以免造成火灾、触电或人身伤害。

21. 清洁设备时, 请用干燥软布轻轻擦拭, 不可使用湿布, 否则可能会损坏设备。
22. 部分产品配备保护罩, 使用前必须取下。
23. 本使用说明基于严格测试制定, 设计和规格变更恕不另行通知。您可登录我们官方网站查看最新电子版使用说明, 了解产品最新资讯。
24. 部分产品内置锂电池, 必须使用专用充电器充电, 并按正确操作说明, 在规定电压和温度范围内使用。
25. 部分产品使用锂电池供电。这类锂离子电池使用寿命有限, 会逐渐失去储电能力, 这种能力下降不可逆。电池老化时, 产品续航时间会减少。锂离子电池使用寿命预计 2-3 年。请定期检查电池情况, 如果充电时间明显增加或续航时间明显减少, 请考虑更换新电池。
26. 部分产品配备锂电池, 其储存建议如下: 储存前, 将电池充放电至约 50% 电量; 至少每 6 个月充电一次, 至约 50% 电量; 可拆卸电池应单独存放; 储存温度在 0°C 至 40°C 范围内。
27. 部分产品使用锂电池供电, 请注意以下事项:
 - 不要拆卸、压碎或刺穿电池;
 - 避免使电池触点短路;
 - 不要在火中或水中处理电池;
 - 不要将电池暴露在 60°C 以上高温下;
 - 将电池放在儿童接触不到的位置;
 - 防止电池遭受过度冲击或振动;
 - 不要使用已损坏的电池;
 - 如果电池出现泄漏, 请避免接触泄漏液体;
 - 如果眼睛接触电池液体, 立即用水冲洗至少 15 分钟, 抬起眼睑直到没有液体的迹象后及时就医。
28. 处理任何电池前, 请确认并遵守当地相关法律法规。
29. 本设备整机的保修期为一年。消耗品如电池、适配器、电源线等配件不在保修范围内。
30. 私自维修将取消保修资格, 需支付维修费用。
31. 不当操作导致故障不在保修范围。

目录

前言	04
主要特点	04
警告	05
部件名称	06
物料清单	07
可另购附件	07
装卸反光罩 / 闪光灯管	08
调整闪光灯角度	09
开关机	10
显示屏	10
电池说明	11
高速同步	13
M: 手动闪光	13
Multi: 频闪闪光	16
TTL: 自动闪光	17
无线电 (2.4G) 传输	18
闪光模式	21
神牛 2.4G 无线漏闪原因及解决办法	21
造型灯	22
自定义功能	23
同步插孔触发	24
保护功能	24
规格参数	26
固件升级	27
维护保养	27

前言

AD600Proll 一体式外拍闪光灯是一款无线 TTL 大功率闪光灯，可拆卸锂电池，携带方便；采用内置神牛 2.4G 无线 X 系统，配合 XPro、XProII、X2T、X3 系列引闪器可远程控制 M/Multi/TTL 模式触发 AD600Proll 闪光；同时，它还可以跟神牛机顶闪光灯、外拍闪光灯、影室闪光灯利用主从属功能组合使用。使用 AD600Proll 闪光灯，您将获得更简单的拍摄体验，在光线变化复杂的情况下，可以自动获得准确的闪光曝光，拍摄轻松自如。

AD600Proll 闪光灯，功率强劲，电池容量大，支持全程高速，单支可压太阳光，外露灯管和高效反光罩为户外拍摄和实景拍摄提供了良好的光质。AD600Proll 是离机闪光中的绝对主力，便携与高效光质兼具，实为自由商业摄影师、新闻记者、发烧友、摄影爱好者、婚纱纪实摄影师等的理想光源。

主要特点

- **极速回电：**0.01-0.9s（最大功率）。
- **色温恒定：**使用此功能全程档位色温漂移在 $\pm 100K$ 左右。
- **LED 造型灯：**40W 双色大功率 LED 造型灯，可自由调节亮度与色温。
- **影棚光质：**功率高达 600Ws，闪光指数 GN87（m ISO 100，使用高效反光罩），全功率闪光 360 次，支持 1/8000 秒高速同步。
- **调光精准：**1/512 到 1/1 间功率调节，每个档位下以 0.1 为增量精确微调，光效把握更随心。
- **全面兼容：**支持佳能、尼康、富士、奥林巴斯、索尼、徕卡、宾得等多种相机的 M/Multi 闪光系统和无线 TTL 系统全面兼容，可作为无线多灯闪光系统的从属单元。
- **无线操控：**内置 2.4G 无线 X 系统，另购神牛引闪器实现远程控制，同时留有 3.5mm 同步插孔，可实现多种同步触发方式。
- **直观显示：**每组组别指示灯拥有专属色彩，16 色变换之间使得在有离机距离时无需查看屏幕便可分辨当前组别。
- **便捷操作：**嵌入 2.8 寸彩屏，搭载滚动拨盘顺滑无极调，拼接式的机身让灯管与电池拆卸间实现分类收纳。
- **附件齐全：**采用保荣卡口，适用范围广泛；可搭配多种光效附件，丰富实用。

警告

- ⚠ 请保持干燥。
- ⚠ 请勿私自拆卸产品，如产品出现故障须由本公司或授权的维修人员进行检查维修。
- ⚠ 禁止拆卸、撞击、挤压或投入火中，若出现严重鼓胀，请勿继续使用。
- ⚠ 请勿将本产品放置在超过 50 度的高温环境中。
- ⚠ 请勿将闪光灯头正对人眼闪光（特别是婴儿的眼睛），否则可能会在短时间内造成视力障碍。
- ⚠ 请勿在化学品、可燃性气体或其他特殊物质附近使用闪光灯，这些物质在特殊情况下可能对闪光灯发出的瞬间强光敏感，有可能导致火灾或电磁干扰。在这些场合下，请注意相关警告标识。
- ⚠ 本产品不能防水，在雨天及潮湿环境下请注意防水。
- ⚠ 使用本产品前请先取下灯头保护盖

部件名称

机身

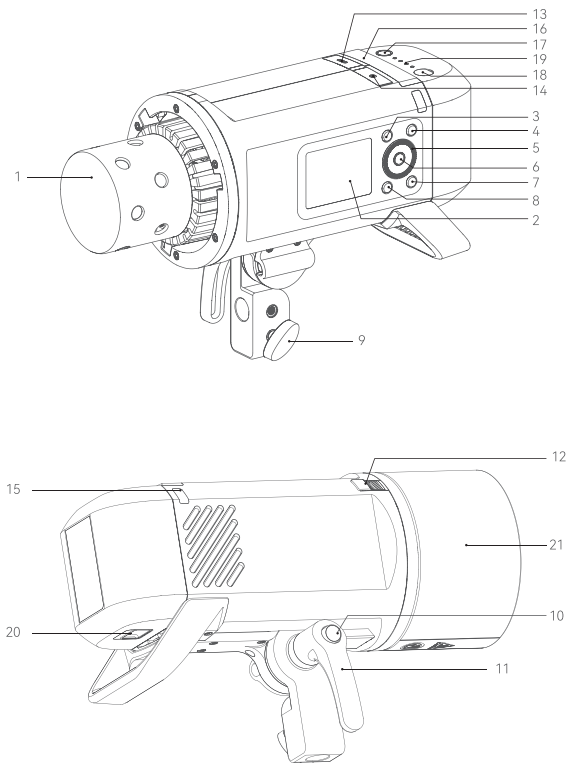

- | | | |
|--------------|------------------|--------------|
| 1. 闪光灯管 | 9. 支架锁紧旋钮 | 17. 电池电量显示按键 |
| 2. 彩屏 | 10. 手柄固定件 | 18. 电池充电孔 |
| 3. MENU 按键 | 11. 手柄 | 19. 电池电量显示灯 |
| 4. MODE 按键 | 12. 卡口推制 | 20. 电池盒推制 |
| 5. 调节拨盘 | 13. USB-C 固件升级接口 | 21. 伞用反光罩 |
| 6. SET 按键 | 14. 3.5mm 同步插孔 | |
| 7. 开关 / 试闪按键 | 15. 组别指示灯 ×2 | |
| 8. 造型灯按键 | 16. 光控接收器 | |

物料清单

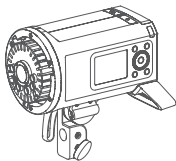

灯体 × 1



灯管 × 1



电池 × 1

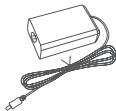

充电器 × 1



电源线 × 1



伞罩保护盖 × 1



伞用反光罩 × 1



说明书 × 1

可另购附件

灯头：H600P 便携灯头。

供电：AC26 交流电源、UC46USB 充电器。

引闪器：XPro、XProll、X2T、X3 系列。

光效附件：伞式快开柔光箱、球形灯笼柔光箱、快装抛物线柔光箱、雷达罩、折叠柔光伞、束光筒和灯架等。

装卸反光罩 / 闪光灯管

安装反光罩：将反光罩对准卡口插入，按住并顺时针旋转，卡口推制将自动锁紧。

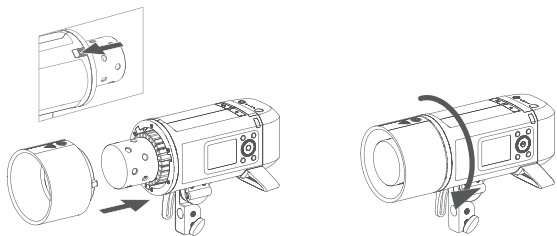

拆卸反光罩：按住卡口推制，将反光罩逆时针旋转解锁。

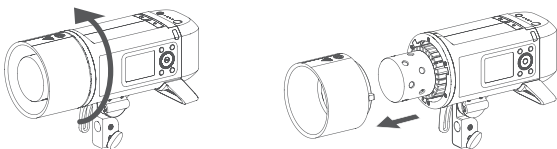

安装灯管：按住卡口推制，卸下反光罩或其他附件后，将闪光灯管对准闪光灯插座插入。

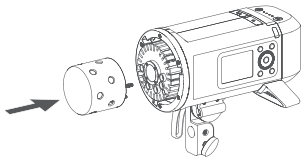

拆卸灯管： 按住卡口推制，卸下反光罩或其他附件后，握住闪光灯管平行拔出。

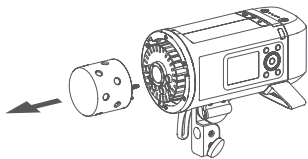

注：装卸闪光灯管时，请务必佩戴手套以确保安全。

调整闪光灯角度

1. 手柄固定件未拔出状态下，逆时针旋转手柄解锁，调整机身需要的角度后，顺时针旋转手柄锁紧即可固定。

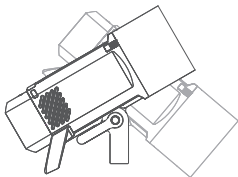

2. 如果旋转手柄时触碰到灯体阻碍，可按住手柄固定件将手柄拔出，拉宽一些距离之后继续上述的动作 1。

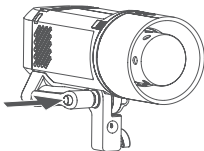

开关机

1. 长按开关按键，屏幕出现解锁图标（）紧接着顺时针旋转调节拨盘即可开机。
2. 长按开关按键，屏幕熄灭即关机完毕。

注：长时间不使用时请关闭电源，本产品设有电源自动关闭功能，可在菜单栏处找到自动关机功能进行设置。

显示屏

(1) M 手动闪光



(2) Multi 频闪光

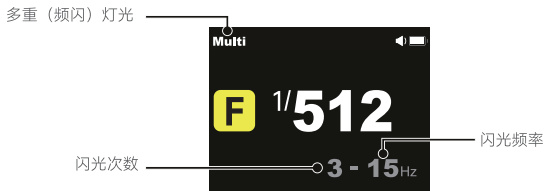

(3) TTL 自动闪光

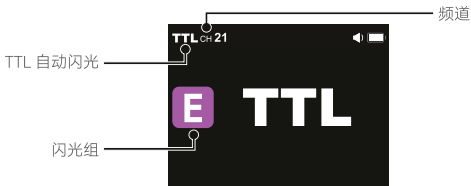

电池说明

特性

1. 本品采用锂电池，支持反复充放电 300 次，使用寿命长。
2. 安全可靠，内置电路有过充保护、过放保护、过流保护、短路保护。
3. 使用标配电池充电器，从低电量到满电的充电时长只需 2 个小时左右。

注意事项

- ⚠ 避免正负极短路。
- ⚠ 电池没有防水功能，不要把电池浸泡在雾、水中。
- ⚠ 放置于儿童不易接触的地方。
- ⚠ 电池充电不要放置超过 24 小时。
- ⚠ 电池应放置于凉爽、干燥及通风的地方存储。
- ⚠ 电池不要靠近和放置于火中。
- ⚠ 电池使用报废后请按当地的规定处理。
- ⚠ 如果电池超过 3 个月不使用，请对电池进行满电充电。

装卸电池

1. 安装：将电池卡槽与主体电池槽对好，往下推直至扣件卡住。

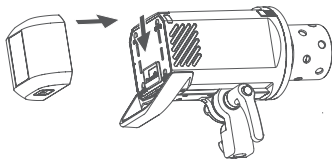

2. 拆卸：按住电池盒推制的同时将电池往上推出电池卡槽，即可取下。

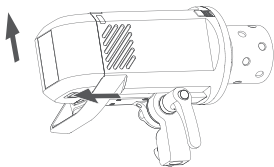

电池电量

正确安装电池后即可给闪光灯供电，短按电池电量显示按键，电量显示灯亮起后可查看当前电池电量，详情可参考下表。

电池上电量显示灯 (无负载下针对电池 电量的指示和管理)	意义
1 红 +3 绿	75% ~ 100%
1 红 +2 绿	50% ~ 75%
1 红 +1 绿	25% ~ 50%
1 红	3% ~ 25%
2% 红灯闪烁, 1% 指示灯不亮	< 2% 电量即将用尽, 此状态不支持闪光灯工作, 前一分钟报警提示, 3 分钟后将自动关机。 注: 此状态请尽快 (10 天内) 充电, 才可使用或放置。

注: 显示大体一致, 但在档位交替时会有些差别。

电池激活说明

因 AD600ProII 电池升级, 如果您超过一个月没有使用电池, 电池会自动进入休眠状态。如果您一个月后再次使用电池或给电池充电, 请您尝试激活电池。

激活方法: 短按电池电量显示按键右侧即可激活。

高速同步

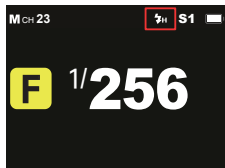

使用高速同步（FP 闪光），您可以在所有的快门速度下同步使用闪光灯。高速同步模式下，使用光圈优先对人像进行填充闪光时特别方便。

1. 短按 MENU 按键进入菜单，旋转拨盘选中高速同步，短按 SET 按键并旋转拨盘可选开启或关闭，设置完毕短按 MENU 按键返回主界面，上方状态栏可见（）。



2. 请使用 X1 系列 /XProI 系列 /XProII 系列 /X2T/X3 系列引闪器

注：

- 如果设置快门速度等于或慢于相机的最大闪光同步速度，取景器中将不显示  图标。
- 使用高速同步，快门速度越高，有效的闪光范围就越小。
- 要恢复普通闪光，请进入菜单栏将高速同步功能关闭，主界面中 <  > 图标会消失。
- 在高速同步模式下，无法设置频闪闪光。
- 连续高速同步闪光 50 次后，闪光灯热保护功能可能会被激活。

M: 手动闪光

您可以在 1/512 功率至 1/1 全功率间以 0.1 档为增量设置闪光输出。为获得正确的闪光曝光，请使用手持的闪光测光表确定所需的闪光输出。短按 MODE 按键令屏幕显示 < M >，旋转拨盘设置闪光输出功率。

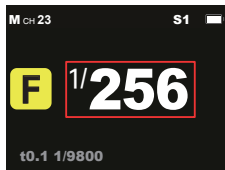

显示闪光输出

拍摄过程中更改闪光输出时，下表将清楚地显示光圈值是如何更改的，您可以在增加或减少闪光输出时查看光圈值的更改规律。

顺时针旋转拨盘递增闪光输出，逆时针旋转拨盘递减闪光输出。

1/512	1/512 (0.1 至 0.9)
1/256	1/256 (0.1 至 0.9)
1/128	1/128 (0.1 至 0.9)
1/64	1/64 (0.1 至 0.9)
1/32	1/32 (0.1 至 0.9)
1/16	1/16 (0.1 至 0.9)
1/8	1/8 (0.1 至 0.9)
1/4	1/4 (0.1 至 0.9)
1/2	1/2 (0.1 至 0.9)
1/1	(全功率)

S1 光控单元设置

短按 MENU 按键进入菜单，旋转拨盘选中光控引闪，短按 SET 按键并旋转拨盘可选关闭 / S1/S2，设置 S1 后短按 MENU 按键返回主界面。

此时闪光灯可作为副灯使用，创造多种照明效果，适用于手动闪光环境。它会与主闪光灯的第一次闪光同步触发闪光，效果与使用无线引闪器一致。

S2 光控单元设置

短按 MENU 按键进入菜单，旋转拨盘选中光控引闪，短按 SET 按键并旋转拨盘可选关闭 / S1/S2，设置 S2 后短按 MENU 按键返回主界面。

此时闪光灯可作为副灯使用，适用于 TTL 闪光环境。具有防预闪功能，使用带一次预闪功能的相机能用光控实现同步拍摄。它会与主闪光灯的第二次闪光同步触发闪光，即 2 次光控引闪。

注：只有在 M 模式下才支持 S1/S2 光控引闪模式。

显示闪光持续时间

闪光持续时间是指闪光灯从开始发光到达发光半峰值的时间长度。半峰值的表示为 $t=0.5$ 。为了给摄影师提供更详细的拍摄数值，本产品采用 $t=0.1$ 。如下图： $t=0.5$ 与 $t=0.1$ 区别。

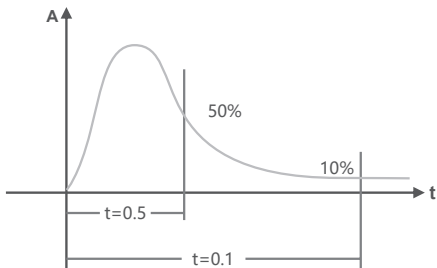

注：只有在 M 模式并关闭高速同步时，才会显示闪光持续时间。

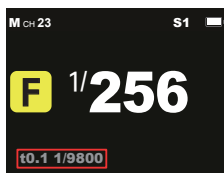

Multi: 频闪闪光

使用频闪闪光，可以发出一系列快速的闪光，它可以在一张照片上拍摄移动物体的多个图像。以下三个步骤依次设置闪光输出、闪光次数和闪光频率（每秒的闪光次数，以 Hz 表示）。

1. 短按 MODE 按键令屏幕显示 <Multi>，旋转拨盘设置闪光输出功率。
2. 短按 SET 按键，旋转拨盘设置闪光次数。
3. 短按 SET 按键，旋转拨盘设置闪光频率。

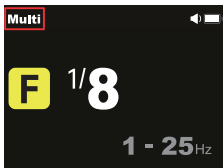

计算快门速度

在频闪闪光过程中，到闪光停止为止快门应保持开启状态。使用下面的公式计算快门速度，然后用相机进行设置。

闪光次数 / 闪光频率 = 快门速度

例如，如果闪光次数是 10，闪光频率是 5Hz，快门速度则至少为 2 秒。

注：

- 反光很强的被摄体在暗背景前使用频闪闪光更加有效。
- 推荐使用三脚架和 TTL 引闪器。
- 闪光输出为 1/1 和 1/2 时不能设置频闪闪光。
- 频闪闪光时也可以使用“buLb”。
- 如果闪光次数显示为 --，则闪光灯会连续闪光，直到快门或电池耗尽。如下表所示，闪光次数将受到限制。

最大频闪闪光次数

闪光输出 \ Hz	1	2	3	4	5	6-7	8-9	10	11	12-14	15-19	20-50	60-100
1/4	7	6	5	4	3	3	3	2	2	2	2	2	2
1/8	14	14	12	10	8	6	5	4	4	4	4	4	4
1/16	30	30	30	20	20	20	10	8	8	8	8	8	8
1/32	60	60	60	50	50	40	30	20	20	20	18	16	12
1/64	90	90	90	80	80	70	60	50	40	40	35	30	20
1/128	100	100	100	100	100	90	80	70	70	60	50	40	40
1/256	100	100	100	100	100	90	80	70	70	60	50	40	40
1/512	100	100	100	100	100	90	80	70	70	60	50	40	40

TTL: 自动闪光

在 TTL 模式下，相机的测光系统会侦查从主体反射回来的闪光照明，从而自动调节闪光输出量，使主体和背景得到均衡曝光。通过短按 MENU 按键进入菜单开启无线功能，将组别设置为 A 至 E 中的任意一个，设置完毕短按两次 MENU 回到主界面。



短按 MODE 按键令屏幕显示 <TTL>，可以使闪光灯进入 TTL 模式。

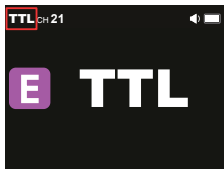

无线电 (2.4G) 传输

AD600ProII 使用 2.4G 无线 X 系统，可以与本厂其他型号完美结合使用。作为从属单元可兼容的相机有佳能、尼康、索尼、奥林巴斯、松下、富士、宾得、莱卡等，根据主控单元自动切换，无需手动设置。

AD600ProII 作为从属单元，可受控带无线发射功能的主控单元，型号如下：
XPROII 系列 /X3 系列 /X2T 系列 /V1Pro 系列 /V1 系列 /V860III 系列等。

无线设置

短按 MENU 按键进入菜单，旋转拨盘选中无线，短按 SET 按键并旋转拨盘可选无线开关 / 频道 / 组别 / 识别号 / 无线同步，短按 SET 按键并旋转拨盘可对其中一项进行设置，设置完毕短按 MENU 按键返回菜单，再次短按 MENU 按键返回主界面。

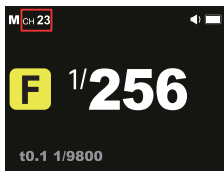

设置通讯频道

如果在拍摄现场不止一个无线闪光系统，您可以通过更改通讯频道或设置识别号来防止信号干扰，保证主控单元和从属单元设置为相同的频道编号即可。

无线	开 / 关
频道	1-32
组别	0-9、A-F
识别号	关闭、1-99
无线同步	短按 SET 按键进行无线同步

使用方法以 X3 引闪器为例：

1. 关闭相机电源，将引闪器放置于相机热靴插座上，打开引闪器电源开关和相机电源。
2. 设置引闪器 X3：从顶端往下滑动屏幕，令屏幕显示 < 设置 >，点击 < 设置 > 进入自定义菜单，点击无线设置进入频道、识别号设置。从左侧往右滑动屏幕可回到主界面，在主界面可设置组别的闪光模式或闪光功率档位。
3. 设置闪光灯 AD600Proll：短按 MENU 按键选中无线，进入无线设置开启此功能，将频道、识别号设置成同引闪器一致。
4. 点击引闪器上的无线同步，闪光灯选中无线同步后短按 SET 按键即可设置双方无线频道、识别号为一样号码。
5. 按下相机快门即可引闪。

无线闪光拍摄

定位和操作范围（无线闪光拍摄的示例）

- 使用一个从属单元进行自动闪光拍摄

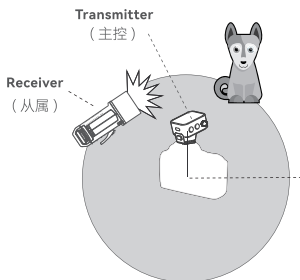

注：

1. 使用带无线发射功能的主控单元作为发射端。
2. 开始拍摄前请进行测试闪光和试拍。
3. 受位置、周围环境、天气状况等影响，传输距离可能更短。
4. 主控内可设置从属闪光关闭（OFF）

传输距离约 100 米

无线多重闪光拍摄

可以将从属单元分割为两个或三个组并在改变闪光光比（倍率）的同时进行 TTL 自动闪光拍摄。此外，可以为各闪光组设定并用不同的闪光模式拍摄。

- 用两个从属组进行自动闪光拍摄。

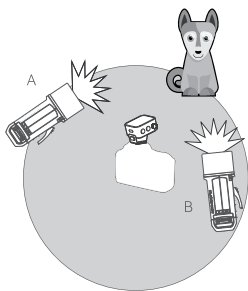

- 用三个从属组进行自动闪光拍摄。

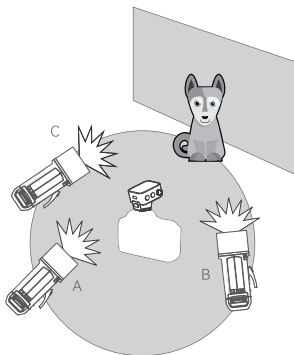

闪光模式

短按 MENU 按键进入菜单，旋转拨盘选中闪光模式，短按 SET 按键并旋转拨盘可选标准 / 色温 / 凝固。

标准	标准闪光，主界面无指示。
色温	色温恒定，开启后主界面出现图标 (C)，组别指示灯会闪烁，蜂鸣器开启状态下会响一分钟，此时请按试闪按键放电，即可正常使用。仅在 M 模式并关闭高速同步时支持开启，使用此功能全档位色温漂移在 $\pm 100K$ 左右。
凝固	凝固模式，开启后主界面出现图标 (F)，闪光时间比标准模式要短，功率对比标准模式也较小，仅在 M 模式和 Multi 模式下支持开启。

神牛 2.4G 无线漏闪原因及解决办法

1. 外部环境 2.4G 信号干扰 (如无线基站、2.4Gwifi 路由、蓝牙设备等)

→请调节引闪器的频道 CH 设置 (建议 +10) 找到无干扰的频道，或者在工作时关闭其他 2.4G 设备。

2. 请确认闪光灯是否已经回电或回电速度是否跟上连拍速度，并且没有处于过热保护或者其他异常状态中。

→请下调闪光灯档位，如是 TTL 模式请尝试改为 M 模式 (TTL 模式下需要预闪一次)。

3. 是否引闪器和闪光灯距离太近 (距离 <0.5m)

→请在引闪器上打开“近距离无线模式”

X1 系列：按住引闪按钮不放，然后开机，直至指示灯闪 2 次。

Xpro、X2T 系列：设置 C.Fn-DIST 为 0-30m。

X3 系列：设置引闪距离为 0-30m。

4. 是否引闪器和接收端设备在低电状态

→请更换电池或充电处理，确保引闪器和闪光灯设备电量充足。

造型灯

AD600ProII 配置 40W 双色大功率 LED 造型灯，短按造型灯按键进入设置，旋转拨盘可选关闭 / 打开 / 跟随，短按 SET 按键并旋转拨盘可对其中一项进行设置，设置完毕短按造型灯按键返回主界面。



关闭	亮度 (以 1% 为增量)	色温 (以 100K 为增量)
打开	10%-100%	2800K-6000K
跟随	跟随闪光功率	2800K-6000K

自定义功能

图标	功能	选项	说明
	无线	关	关闭无线设置
		开	设置通讯频道
	闪光模式	标准	标准闪光
		色温	M 非高速模式下支持开启
		凝固	M 模式和 Multi 模式下支持开启
	光控引闪	关	关闭光控引闪
		S1	M 模式下支持开启
		S2	
	高速同步	关	关闭高速同步
		开	M 模式下支持开启
	造型灯	闪灭	闪光灯回电灭
		持续	常亮
	蜂鸣器	关	蜂鸣器关闭
		开	蜂鸣器开启
	功率显示	1/512	机器闪光档位显示为 1/512-1/1
		1.0	非高速模式下机器闪光档位显示为 1.0-10.0
	屏幕待机	30 秒	超过 30 秒无人操作，屏幕进入休眠
		1 分钟	超过 1 分钟无人操作，屏幕进入休眠
		2 分钟	超过 2 分钟无人操作，屏幕进入休眠
		3 分钟	超过 3 分钟无人操作，屏幕进入休眠
	自动关机	关	关闭自动关机
		30 分钟	30 分钟后自动关机
		60 分钟	60 分钟后自动关机
		90 分钟	90 分钟后自动关机
		120 分钟	120 分钟后自动关机
	屏幕亮度	20%-100%	旋转拨盘设置亮度值
	延时闪光	关	关闭延时闪光
		0.01-30.0 秒钟	以 0.01 秒钟为增量
	蒙版	2 蒙板	旋转拨盘设置
		3 排序	
		4 排序	

	语言	中文	界面中字体显示简体中文
		English	界面中字体显示 English
	恢复出厂设置	是	恢复出厂设置
		否	取消恢复出厂设置
	设备信息	无选项	查看当前机器型号及版本号

同步插孔触发

同步插孔规格为 $\Phi 3.5\text{mm}$ ，此处可插入同步线或者触发器触发插头对闪光灯进行同步引闪。

保护功能

1. 热保护

- 为防止闪光灯过热并损坏，请勿在 1/1 功率时进行超过 80 次的快速连续闪光。80 次连续闪光后，要让闪光灯至少冷却 10 分钟。
- 如您在进行超过 80 次连续闪光后马上继续进行更多次闪光，内部的防过热功能可能会被激活，使回电时间变为 10 秒以上。如果发生这种现象，请让闪光灯冷却约 10 分钟，闪光灯便会恢复正常。
- 热保护启动后，显示屏上会显示符号 <  >

激活热保护功能的连续闪光次数：

功率	次数
1/1	80
1/2 (+0.7~+0.9)	105
1/2 (+0.3~+0.6)	125
1/2 (+0.0~+0.2)	160
1/4 (+0.7~+0.9)	185
1/4 (+0.3~+0.6)	245
1/4 (+0.0~+0.2)	320
1/8 (+0.7~+0.9)	375
1/8 (+0.3~+0.6)	490
1/8 (+0.0~+0.2)	640
1/16(+0.0 ~ +0.9)	800
1/32(+0.0 ~ +0.9)	1065

功率	次数
1/64(+0.0 ~ +0.9)	1065
1/128(+0.0 ~ +0.9)	2100
1/256(+0.0 ~ +0.9)	2100
1/512(+0.0 ~ +0.9)	2100

高速同步模式下, 激活热保护功能的连续闪光次数:

功率	次数
1/1	50
1/2(+0.0 ~ +0.9)	60
1/4(+0.0 ~ +0.9)	80
1/8(+0.0 ~ +0.9)	105
1/16(+0.0 ~ +0.9)	128
1/32(+0.0 ~ +0.9)	210
1/64(+0.0 ~ +0.9)	
1/128(+0.0 ~ +0.9)	
1/256(+0.0 ~ +0.9)	

2. 其他保护

为了保证设备安全的工作, 系统时刻进行预防保护, 以下提示符号供您参考:

屏幕显示	警示内容
Error1	闪光灯回电系统出现问题, 无法回电引闪, 请重新开机, 如无法解决请维修
Error3	闪光灯管两端电压过高, 请维修
Error9	固件升级有误, 请进行正确固件升级

规格参数

型号	AD600Proll
无线从属单元模式	无线电模式 (兼容佳能 E-TTL II、尼康 i-TTL、索尼、奥林巴斯、松下、富士、徕卡、宾得)
闪光模式	无线电关闭: M/Multi 无线电从属模式: TTL/M/Multi
闪光指数 (1/1 档位)	87 (ISO 100, 以米为单位, 使用高效反光罩)
闪光持续时间 (t=0.1)	标准: 1/220 秒 ~ 1/11760 秒 色温: 1/220 秒 ~ 1/7400 秒 凝固: 1/2570 秒 ~ 1/20400 秒
功率 (1/1 档位)	600Ws
档位	10 级: 1/512 ~ 1/1 (每个档位下以 0.1 为增量微调)
频闪闪光	具备 (次数: 100 次; 频率: 100Hz)
同步方式	高速同步 (最高 1/8000 秒), 前帘同步, 后帘同步
延时引闪	0.01 ~ 30 秒
蒙版	√
风扇	√
蜂鸣器	√
显示闪光持续时间	√
光控引闪	S1/S2/OFF
显示	彩屏
造型灯	
最大输入功率	40W
亮度调节范围	10%-100%
CRI	平均 ≥ 97
TLCI	平均 ≥ 98
CCT	2800K-6000K
无线闪光 (2.4G 无线功能)	
无线功能	从属单元 / 关闭
可控制从属单元组	16 组: 0-9、A-F
传输距离	约 100 米
频道	32 组: 1-32
ID 识别号	01-99/OFF

电源	
电源	锂电池 (28.8V/2600mAh)
全功率闪光次数	360 次
回电时间	约 0.01 ~ 0.9 秒
电池电量显示灯	√
节能	可设置闪光灯在无人操作时 30 分钟 ~ 120 分钟自动关闭电源
同步触发方式	3.5mm 同步线
闪光管色温	5800±200K
尺寸和重量	
尺寸 (含电池、不含灯管、反光罩)	≈ 250×245×125mm
净重 (含电池、不含灯管、反光罩)	≈ 3kg

固件升级

- 本机通过 USB-C 固件升级接口可进行固件升级，软件最新公告及说明将会发布在官方网站上。
- 本品出厂不配 USB 升级线，请另行购买。本产品 USB 接口为 USB-C 接口，请使用 USB-C 线。
- 产品升级固件需要 Godox G3 程序软件支持，升级固件前请先到神牛官网下载安装“Godox G3 固件升级软件”再选择相应的固件文件。
- 由于产品进行固件升级，说明书请以最新电子版为准。

维护保养

- 闪光灯在工作时，如发现异常，应立即关掉电源，查明原因。
- 灯体应避免震动，平时注意表面除尘。
- 灯体稍有发热为正常现象，无特别需要时，勿连续引闪。
- 闪光灯的所有维修一概由本厂指定可供原厂配件之维修部负责。
- 1 年保修，消耗品如灯管等不在 1 年保修范围。
- 经发现，擅自检修此闪光灯的，将取消闪光灯之一年保修期，维修需要收取相关费用。
- 如果本品出现故障或者被水淋湿，在专业人员维修后方可继续使用。
- 如有技术更改，恕不另行通知。

Important Safety Instructions

This product is a professional photographic equipment, to be operated by professional personnel only.

The following basic safety precautions must be followed when using this product:

All transport protective materials and packaging on the product must be removed before use.

1. Carefully read and fully understand the instruction manual before use and strictly follow the safety instructions. Failure to do so may result in death, serious injury, damage to the product, or other property damage.
2. High voltage exists when the flash is powered on. Internal capacitors will remain charged for some time after power off.
3. This product is a professional lighting fixture, children are prohibited from using it. Children must be closely supervised by adults when approaching the fixture, to prevent collisions with the fixture or unauthorized use that could cause personal injury.
4. This is not an ordinary lighting fixture and must not be used for general illumination. Anyone with a history of eye damage or sensitivity should avoid using this fixture or looking directly at it.
5. Extreme caution must be exercised when using it, do not touch high-temperature parts such as flash tubes to avoid burns.
6. Do not point the flash directly at the eyes (especially baby's eyes) under any circumstances, as this could impair vision in a short time. Turn off immediately if discomfort occurs, stop using, and seek medical attention promptly.
7. If the flash tube is damaged, stop using it immediately and contact the manufacturer, service agent, or qualified repair personnel for a replacement to prevent accidents.
8. Do not use damaged equipment or accessories. Allow professional repair technicians to inspect and confirm normal operation before continuing use after repairs.
9. Disconnect power source or remove batteries (if it has one) before replacing flash tube, protective glass, or fuses. Allowing 10 minutes to cool before replacing flash tube, and wear insulated or heat resistant gloves when operating.
10. Turn off power before connecting or disconnecting plugs from outlets. Ensure plugs are fully inserted when connecting.
11. Stop using immediately if the product shell is cracked due to falling, squeezing, or strong impact, to avoid touching the internal electronic components and getting an electric shock.
12. Some products have long power cords, please place them properly to avoid contact with heat sources or tripping others. It is recommended to use the original power cord. Damage caused by non-original cords is not covered by the warranty.
13. Unplug the equipment power plug from the power socket before cleaning or maintenance. Do not pull the power cord forcibly, use both hands to hold the plug end and pull it out.
14. This device is not waterproof. Keep it dry and avoid immersing it in water or other liquids. It should be installed in a ventilated and dry location and avoid using in rainy, humid, dusty, or overheated environments. Do not place items above the device or allow liquids to flow into it to prevent danger.
15. Do not disassemble without authorization. If the product malfunctions, it must be inspected and repaired by our company or authorized repair personnel.
16. Before storing the device, ensure it has completely cooled down and the power cord is unplugged, then put it in the protective case or a ventilated dry location.
17. Do not place the device near alcohol, gasoline, or other flammable volatile solvents or gases such as methane and ethane.

18. Do not use or store this device in potentially explosive environments.
19. Do not cover the heat dissipation port!
20. Do not use accessories not been approved by our company, as this may cause fire, electric shock or personal injury.
21. Clean gently with a dry cloth. Do not use a wet cloth as it may damage the device.
22. Some products are equipped with protective covers that must be removed before use.
23. This instruction manual is based on rigorous testing. Changes in design and specifications are subject to change without notice. Check official website for latest instruction manual and product updates.
24. Use only specified charger and follow proper usage instructions for certain products with built-in lithium batteries, within the rated voltage and temperature range.
25. Some products are powered by lithium batteries, who have limited lifespans and will gradually lose their charging capacities, which is irreversible. As the battery ages, the product's battery life will decrease. The lifespan of lithium battery is estimated to be 2 to 3 years. Please regularly check the battery, and if the charging time significantly increases or the battery life significantly decreases, consider replacing the battery.
26. Some products are equipped with lithium batteries. The following are the storage recommendations: Charge the battery to about 50% before storage. Charge it to about 50% at least every six months. Removable batteries should be stored separately. The storage temperature should be between 0°C and 40°C.
27. Some products are powered by lithium batteries. Please note:
 - Do not disassemble, crush, or puncture the battery;
 - Avoid short-circuiting the battery contacts;
 - Do not expose the battery to fire or water;
 - Do not expose the battery to temperatures above 60°C;
 - Keep out of reach of children;
 - Protect the battery from excessive shock or vibration;
 - Do not use a damaged battery;
 - If the battery leaks, avoid contact with the leaking fluid;
 - If the battery fluid comes into contact with your eyes, immediately rinse with water for at least 15 minutes. Lift your eyelids until there are no signs of fluid and seek medical attention promptly.
28. Confirm and comply with all relevant local laws and regulations when handling any batteries.
29. The warranty period for this device as a whole is one year. Consumables (such as batteries), adapters, power cords, and other accessories are not covered by the warranty.
30. Unauthorized repairs will void the warranty and will incur charges.
31. Failures from improper operation is not covered under warranty.

Content

Foreword	31
Main Features	31
Warning	32
Name of Parts	33
What's Inside	34
Separately Sold Accessories	34
Installing and Disassembling Reflector/Flash Tube	35
Adjusting Flash Angle	36
Power Switch	37
Color Screen	37
Battery	38
High-Speed Sync	40
M: Manual Flash	40
Multi: Stroboscopic Flash	43
TTL Auto Flash	44
Wireless (2.4G) Transmission	45
Wireless Settings	45
Flash Mode	48
The Reason & Solution of Not Triggering in Godox 2.4G Wireless	48
Modeling Lamp	49
C.Fn: Setting Custom Functions	50
Sync Triggering	51
Protection Function	51
Technical Data	53
Firmware Upgrade	54
Maintenance	54

Foreword

Thank you for purchasing!



AD600ProII has strong power, detachable lithium battery pack and great portability. When using Godox 2.4G wireless X system, it can be triggered by XPro/XProII/X2T/X3 series flash trigger in M/Multi/TTL mode. With transmitter & receiver functions, AD600ProII can also use in combination with Godox camera flashes, outdoor flashes, studio flashes, etc. With this flash, your shooting will become simpler. With high-speed shooting throughout the process, single fixture overshadowing the sunlight, bare flash tube and reflector make a perfect match for outdoor and live shooting, AD600ProII is an ideal light source for freelance commercial photographers, journalists, photography enthusiasts, wedding documentary photographers, etc.

Main Features

- **Quick Recycle Time:** 0.01s~0.9s (max. power).
- **Stable Color Temperature:** shift around $\pm 100\text{K}$ over the entire power range with this function.
- **LED Modeling Lamp:** 40W bi-color large LED modeling light freely adjusts brightness and CCT.
- **Studio Quality Light:** up to 600Ws, GN 87 (m ISO 100, with efficient reflector), 360 full power flashes, 1/8000s high-speed sync.
- **Precise Power Adjustment:** from full power 1/1 to 1/512 with 0.1 increment each step.
- **Wide Compatibility:** fully support M, Multi and wireless TTL flash systems of Canon, Nikon, Fujifilm, Olympus, Sony, Leica, Pentax, etc. Workable as a receiver unit in a wireless flash group.
- **Wireless Control:** with built-in 2.4G wireless X system to achieve remote control by optional Godox flash triggers, and 3.5mm sync cord jack to achieve various sync triggering modes.
- **Distinct Group Colors:** 16 groups with different colors to quickly distinguish even in remote distance usage.
- **Simple Operation:** 2.8" color screen together with steplessly rotatable select dial, detachable battery pack design.
- **Wide-range Accessories:** Bowens mount has wide compatibility and versatility.

Warning

- ▲ Always keep this product dry.
- ▲ Do not disassemble. Should repairs become necessary, this product must be sent to an authorized maintenance center.
- ▲ Stop using this product if it breaks open due to extrusion, falling or strong hit. Otherwise, electric shock may occur if you touch the electronic parts inside it.
- ▲ Do not leave or store the flash unit if the ambient temperature reads over 50°C.
- ▲ Do not fire the flash directly into the eyes (especially those of babies) within short distances. Otherwise visual impairment may occur.
- ▲ Do not use the flash unit in the presence of flammable gases, chemicals and other similar materials. In certain circumstances, these materials may be sensitive to the strong light emitting from this flash unit and fire or electromagnetic interference may result.
- ▲ This product is not waterproof, do not use in rain or in damp conditions.
- ▲ Please remove the flash head protection cover before using.

 	<p>CAUTION Hot surface. Do not touch. Burned fingers when handling the parts. Wait one-half hour after switching off before handling parts.</p>
---	---

Name of Parts

Flash Body

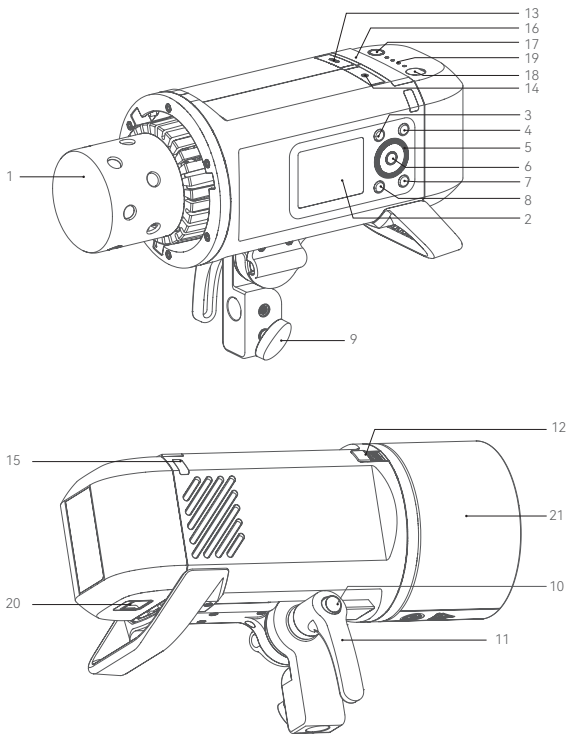

- | | | |
|-----------------------------|------------------------------|--------------------------------|
| 1. Flash Tube | 9. Bracket Locking Knob | 17. Battery Indicator Button |
| 2. Color Screen | 10. Handle Fixing Fastener | 18. Battery Charging Port |
| 3. MENU Button | 11. Handle | 19. Battery Level Indicator |
| 4. MODE Button | 12. Accessory Locking Pusher | 20. Battery Compartment Pusher |
| 5. Select Dial | 13. USB-C Port | 21. Reflector |
| 6. SET Button | 14. 3.5mm Sync Cord Jack | |
| 7. Power Switch/Test Button | 15. Group Indicator ×2 | |
| 8. Modeling Lamp Button | 16. Photocell Receiver | |

What's Inside



Flash Body × 1



Flash Tube × 1



Battery × 1



Charger × 1



Power Cord × 1



Reflector Protection Cover × 1



Reflector × 1



Instruction Manual × 1

Separately Sold Accessories

Flash Head: H600P Portable Flash Head.

Power Supply: AC26 Power Source, UC46 USB Charger.

Flash Trigger: XPro, XProII, X2T, X3 series.

Optical Accessories: Umbrella Softbox, Collapsible Lantern Softbox, Quick-loading Parabolic Softbox, Beauty Dish, Umbrella Diffuser, Snoot, Light Stand, etc.

Installing and Disassembling Reflector/Flash Tube

Installing the Reflector: Insert the reflector into the accessory mount , press and hold then rotate clockwise, the accessory locking pusher will lock up.

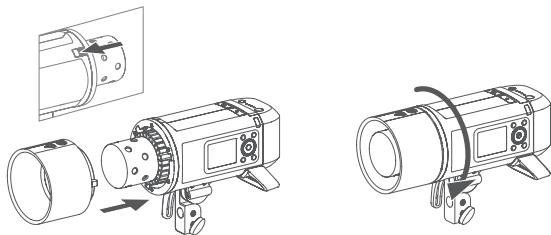

Disassembling the Reflector: Press down the accessory locking pusher, rotate the reflector anticlockwise to unlock.

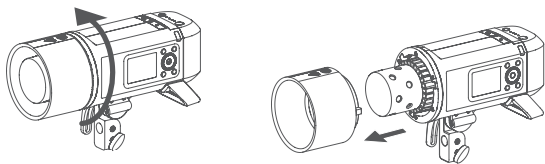

Installing the Flash Tube: Press down the accessory locking pusher, remove the reflector or other accessories. Match the flash tube in the tube socket and push until it is securely seated into the socket.

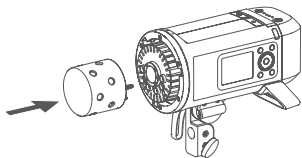

Disassembling the Flash Tube: Press down the accessory locking pusher, remove the reflector or other accessories. Grasp the flash tube and pull it out horizontally.

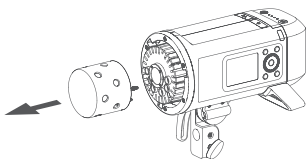

Note: Please wear gloves for the above operations.

Adjusting Flash Angle

1. When the handle fixing fastener is not pulled out, rotate the handle anticlockwise to unlock it, adjust the flash body for the desired angle, then rotate the handle clockwise to tighten.

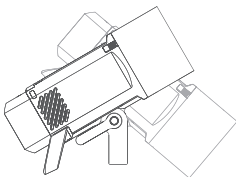

2. If the handle collides the flash body in rotation, please press the handle fixing fastener and pull out the handle, repeat the step 1 after stretching out a few distance.

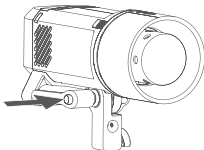

Power Switch

1. Long press the power switch button until the unlock icon is displayed on the panel, then rotate the select dial clockwise to turn on the device.
2. Long press the power switch button until panel black out to turn off the device.

Note: Turn off the device if it will not be used for an extended period. This device is designed with an automatic power off function, which can be set in menu settings.

Color Screen

(1) M (Manual) Flash



(2) Multi Flash

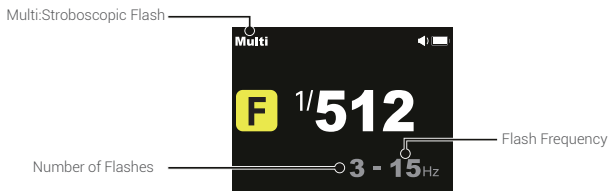

(3) TTL Auto Flash

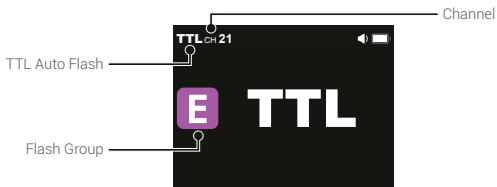

Battery

Features

1. This flash unit uses lithium battery which has long runtime. The available charge-and-discharge times are 300.
2. It is reliably safe. The inner circuit is against overcharge, overdischarge, overcurrent, and short circuit.
3. It takes only 2 hours to fully charge the battery by using the standard battery charger.

Cautions

- ▲ Do not short circuit.
- ▲ Do not expose to rain or immerse into water. This battery is not water proof.
- ▲ Keep out of reach of children.
- ▲ No over 24 hours' continuous charging.
- ▲ Store in dry, cool, ventilated places.
- ▲ Do not put aside or into fire.
- ▲ Dead batteries should be disposed according to local regulations.
- ▲ If the battery had ceased using for over 3 months, please make a full recharge.

Loading and Unloading the Battery

1. Loading: Match the battery's groove with the main battery compartment's ridge. Push down the battery pack until it is locked.

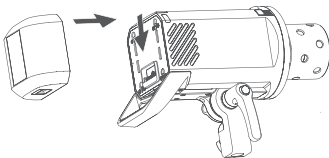

2. Unloading: Push the battery compartment pusher and the battery pack upward at the same time to unload it.

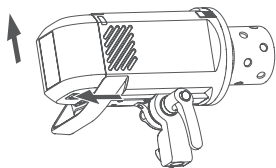

Battery Level Indication

Attach the battery pack to the flash correctly. Check the battery level by pressing the battery indicator button and lightening the battery level indicator as the following table shows.

LED Battery Level Indication on the Battery (Indicating battery level and management of non-loaded battery)	Meaning/Percentage of Battery Level
1 red grid +3 green grids	75% ~ 100%
1 red grid +2 green grids	50% ~ 75%
1 red grid +1 green grid	25% ~ 50%
1 red grid	3% ~ 25%
2% flash red, 1% off	< 2% The battery level is going to be used out immediately. And the flash will alarm for 1 minute and auto power off in 3 minutes. Note: Please recharge the battery as soon as possible (within 10 days). Then, the battery can be used or be placed for long period.

Note: The indications are almost the same except for the grids shift.

Battery Activation Instructions

Due to the battery upgrade, if you haven't used the battery for more than a month, it will automatically go to sleep. please try to activate it if you use or charge again after a month.

Activation method: Short press the right side of battery indicator button to activate.

High-Speed Sync

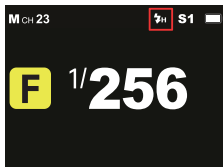

High speed sync (FP flash) enables the flash to synchronize with all camera shutter speeds. This is convenient when you want to use aperture priority for fill-flash portraits.

1. Press the MENU button to enter menu interface, turn the select dial and press the SET button to enter high speed sync and turn on it. Then press MENU button to return to the main interface, the HSS icon <  > can be seen on the panel.



2. Please use X1/XProI /XProII /X2T/X3 series flash triggers.

Note:

- If you set a shutter speed that is the same as or slower than the camera's maximum flash sync speed, <  > will not be displayed in the viewfinder.
- With high-speed sync, the faster the shutter speed, the shorter the effective flash range.
- To return to normal flash, turn off the high-speed sync function in menu settings. Then <  > will disappear.
- Multi flash mode cannot be set in high-speed sync mode.
- Over-temperature protection may be activated after 50 consecutive high-speed sync flashes.

M: Manual Flash

The flash output is adjustable from 1/1 full power to 1/512 power with 0.1 step increment. To obtain a correct flash exposure, use a hand-held flash meter to determine the required flash output.

Press MODE button so that < **M** > is displayed. Turn the select dial to choose a desired flash output amount.

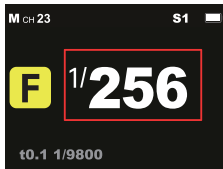

Flash Output Range

The following table makes it easier to see how the step changes in terms of aperture value when you increase or decrease the flash output.

Turn the select dial clockwise to increase the flash output, while turn it anticlockwise to decrease the flash output.

1/512	1/512 (0.1 to 0.9)
1/256	1/256 (0.1 to 0.9)
1/128	1/128 (0.1 to 0.9)
1/64	1/64 (0.1 to 0.9)
1/32	1/32 (0.1 to 0.9)
1/16	1/16 (0.1 to 0.9)
1/8	1/8 (0.1 to 0.9)
1/4	1/4 (0.1 to 0.9)
1/2	1/2 (0.1 to 0.9)
1/1	(full power)

Optical S1 Secondary Unit Setting

Press MENU button to enter photocell and choose S1 function, so that this flash can function as an optical S1 secondary flash with optical sensor in M manual flash mode. Then press then MENU button to return to the main interface. With this function, the flash will fire synchronously when the main flash fires, the same effect as that by the use of wireless triggers. This helps create multiple lighting effects.

Optical S2 Secondary Unit Setting

Press MENU button to enter photocell and choose S2 function, so that this flash can also function as an optical S2 secondary flash with optical sensor in M manual flash mode. Then press then MENU button to return to the main interface. This is useful when cameras have pre-flash function. With this function, the flash will ignore a single "preflash" from the main flash and will only fire in response to the second, actual flash from the main unit.

Note: S1 and S2 optical triggering is only available in M manual flash mode.

Display Flash Duration

Flash duration refers to the length of time that from flash's firing to reach the half peak at maximum. The half peak at maximum is usually expressed as $t=0.5$. In order to provide the photographer with more concrete data, this product adopts $t=0.1$. The difference between $t=0.5$ and $t=0.1$ is shown in the following picture.

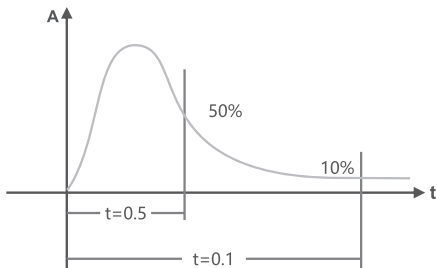

Note: Turn off the high speed sync function in M mode, the flash duration will then be displayed.

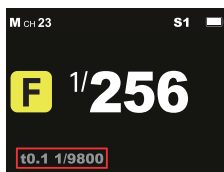

Multi: Stroboscopic Flash

With stroboscopic flash, a rapid series of flashes is fired. It can be used to capture multiple images of a moving subject in a single photograph. You can set the flash output, number of flashes, and flash frequency (number of flashes per sec. expressed as Hz).

1. Press the MODE button so that **< Multi >** is displayed, turn the select dial to choose a desired flash output.
2. Press the SET button and turn the select dial to set the number of flashes.
3. Press the SET button and turn the select dial to set the flash frequency.

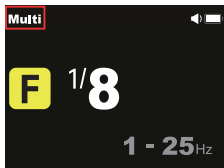

Calculating the Shutter Speed

During stroboscopic flash, the shutter remains open until the firing stops. Use the formula below to calculate the shutter speed and set it with the camera.

Number of Flashes / Flash Frequency = Shutter Speed

For example, if the number of flashes is 10 and the firing frequency is 5 Hz, the shutter speed should be at least 2 seconds.

Note:

- Stroboscopic flash is most effective with a highly reflective subject against a dark background.
- Using a tripod and a TTL flash trigger is recommended.
- A flash output of 1/1 and 1/2 cannot be set for stroboscopic flash.
- Stroboscopic flash can be used with "bulb".
- If the number of flashes is displayed as "--", the firing will continue until the shutter closes or the battery is exhausted. The number of flashes will be limited as shown by the following table.

Maximum Stroboscopic Flashes:

Flash Output \ Hz	1	2	3	4	5	6-7	8-9	10	11	12-14	15-19	20-50	60-100
1/4	7	6	5	4	3	3	3	2	2	2	2	2	2
1/8	14	14	12	10	8	6	5	4	4	4	4	4	4
1/16	30	30	30	20	20	20	10	8	8	8	8	8	8
1/32	60	60	60	50	50	40	30	20	20	20	18	16	12
1/64	90	90	90	80	80	70	60	50	40	40	35	30	20
1/128	100	100	100	100	100	90	80	70	70	60	50	40	40
1/256	100	100	100	100	100	90	80	70	70	60	50	40	40
1/512	100	100	100	100	100	90	80	70	70	60	50	40	40

TTL Auto Flash

In TTL mode, the camera's metering system detects the flash reflected from the subject and automatically adjusts the flash output so that the subject and background are evenly exposed.

Press the MENU button to enter menu interface, turn the select dial and press the SET button to enter wireless and turn on it, set the group among A to E. Press the MENU button to return to the main interface.

Press MODE button to enter TTL mode, the screen will display <TTL>.

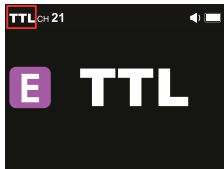
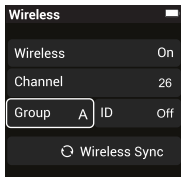

Wireless (2.4G) Transmission

AD600ProII adopts 2.4G wireless X system, which has good compatibility with other Godox products. It can automatically switch to receiver unit according to the transmitter unit instead of setting manually. The compatible cameras include Canon, Nikon, Sony, Olympus, Panasonic, Fujifilm, Pentax, Leica, etc.

As a receiver unit, AD600ProII can be controlled by the following transmitter units: XPROII series/X3 series /X2T series /V1Pro series /V1 series /V860III series.

Wireless Settings

Press the MENU button to enter menu interface, turn the select dial and press the SET button to choose among wireless/channel/group/ID/wireless sync, then turn the select dial and press the SET button to adjust the parameters. Press the MENU button to return to the previous menu, press again to return to the main interface.

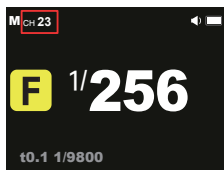
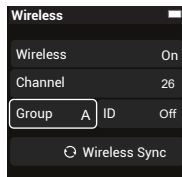

Setting the Communication Channel

If there are other wireless flash systems nearby, you can change the channel to prevent signal interference. The channels of the transmitter unit and the receiver unit(s) must be set to the same.

Wireless	On/Off
Channel	1-32
Group	0-9, A-F
ID	Off, 1-99
Wireless Sync	Press the SET button

Take X3 flash trigger as an example:

1. Turn off the camera and mount the flash trigger on camera hot shoe. Then, power on the flash trigger and the camera.
2. Slide the screen of X3 down from the top to display <Setting>, press <Setting> to enter C.Fn. menu, then press <Wireless> to set CH and ID. Slide the screen from the left to the right to return to the main interface, on which you can set the flash mode and output power level of groups.
3. Press the MENU button of AD600ProII to select wireless and turn it on, then set the CH and ID the same to the flash trigger.
4. Press the wireless sync on the trigger and flash, then press the SET button on the flash can set their CH and ID to the same.
5. Press the camera shutter to trigger.

Wireless Flash Shooting

Positioning and Operation Range (Example of wireless flash shooting)

- Auto flash shooting with one receiver unit

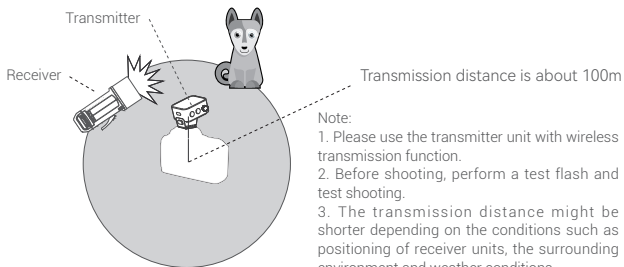

Note:

1. Please use the transmitter unit with wireless transmission function.
2. Before shooting, perform a test flash and test shooting.
3. The transmission distance might be shorter depending on the conditions such as positioning of receiver units, the surrounding environment and weather conditions.
4. The receiver unit can be turned off on the transmitter unit.

Wireless Multiple Flash Shooting

You can divide the receiver units into two or three groups and perform TTL auto flash while changing the flash ratio (factor). In addition, you can set and shoot with a different flash mode for each firing group.

- Auto flash shooting with two receiver units

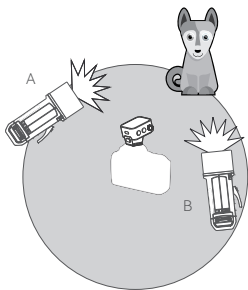

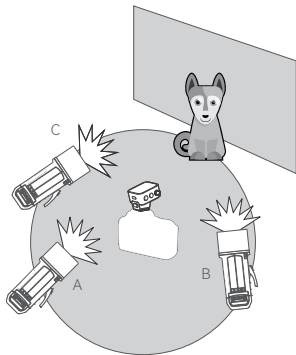

- Auto flash shooting with three receiver units



Flash Mode

Press the MENU button to enter menu interface, turn the select dial and press the SET button to enter flash mode, in which you can choose among normal, color and freeze.

Normal	Normal flash mode, with no indication on the main interface.
Color	Stable color temperature mode, with <  > on the main interface. The group indicator will blink and the beeper will beep for 1min if it has been turned on, please press the test button to resume to normal use. The stable color temperature function is only available in non-HSS M mode, and value of which will shift around $\pm 100K$ over the entire power range.
Freeze	Freeze mode, with <  > on the main interface. The flash duration is shorter than the normal flash mode, and the power is also less than the normal flash mode. The freeze mode is only available in M mode and Multi mode.

The Reason & Solution of Not Triggering in Godox 2.4G Wireless

1. Disturbed by the 2.4G signal in outer environment (e.g. wireless base station, 2.4G wifi router, Bluetooth, etc.)

→ To adjust the channel CH setting on the flash trigger (add 10+ channels) and use the channel which is not disturbed. Or turn off the other 2.4G equipment in working.

2. Please make sure that whether the flash has finished its recycle or caught up with the continuous shooting speed or not (the flash ready indicator is lightened) and the flash is not under the state of over-heat protection or other abnormal situation.

→ Please downgrade the flash power output. If the flash is in TTL mode, please try to change it to M mode.

3. Whether the distance between the flash trigger and the flash is too close or not (< 0.5m).

→ Please turn on "short distance wireless mode" of the flash trigger.

→ X1 Series: Press and hold the triggering button then turn on the device, until the indicator blinks twice.

→ XPro and X2T Series: Please set the C.Fn-DIST to 0-30m.

→ X3 Series: Please set the triggering distance to 0-30m.

4. Whether the flash is in the low battery states or not.

→ Please charge or replace the battery in time, and ensure both devices have enough battery power.

Modeling Lamp

AD600ProII is equipped with 40W bi-color LED modeling lamp. Press the modeling lamp button to enter modeling lamp settings, turn the select dial to choose among off/free/prop, then turn the select dial and press the SET button to adjust the parameters. Press the modeling lamp button to return to the main interface.

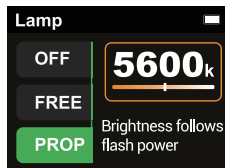
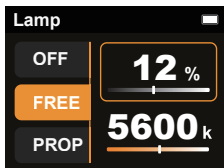



OFF	Brightness(in 1% increment)	CCT(in 100K increment)
FREE	10%-100%	2800K-6000K
PROP	Brightness follows flash power	2800K-6000K

C.Fn: Setting Custom Functions

Press the MENU button to enter menu interface, turn the select dial and press the SET button to choose among the following functions, then turn the select dial and press the SET button to adjust its parameters. Press the MENU button to return to the previous interface, press again to return to the main interface.

Icons	Functions	Options	Notes
	Wireless	Off	Turn off wireless function
		On	Set channel, group and ID
	Flash Mode	Normal	Normal flash mode
		Color	Available in non-HSS M mode
		Freeze	Available in M mode and Multi mode
	Photocell	Off	Turn off photocell
		S1	Turn on photocell in M mode
		S2	
	HSS	Off	Turn off high speed sync
		On	Turn on high speed sync in M mode
	Model	Inter	Modeling lamp off in triggering
		Cont	Modeling lamp constant on
	Beep	Off	Beep is off
		On	Beep is on
	Type	1/512	Flash step displays as 1/512 -1/1
		1.0	Flash step displays as 1.0 -10.0 in non-HSS mode
	Standby	30sec	Screen blacks out in 30sec of idle use
		1min	Screen blacks out in 1min of idle use
		2min	Screen blacks out in 2min of idle use
		3min	Screen blacks out in 3min of idle use
	Auto Off	Off	Turn off auto off function
		30min	Auto off in 30min
		60min	Auto off in 60min
		90min	Auto off in 90min
		120min	Auto off in 120min
	Brightness	20%-100%	Turn the select dial to adjust
	Delay	Off	Turn off delay flash
		0.01s-30.0s	Turn the select dial to adjust in 0.01s increment
	Mask	2Mask	Turn the select dial to adjust
		3Alt	
		4Alt	

	Language	Chinese	Simplified Chinese operating system
		English	English operating system
	Reset	Yes	Factory reset
		No	Cancel factory reset
	Device Info		Display the current model and version

Sync Triggering

The sync cord jack is a $\Phi 3.5$ mm plug. Insert a trigger plug in and the flash will be fired synchronously with the camera shutter.

Protection Function

1. Over-Temperature Protection

- To avoid overheating and deteriorating the flash head, do not fire more than 80 continuous flashes in fast succession at 1/1 full power. After 80 continuous flashes, allow a rest time of at least 10 minutes.
- If you fire more than 80 continuous flashes and then fire more flashes in short intervals, the inner over-temperature protection function may be activated and make the recycling time over 10 seconds. If this occurs, allow a rest time of about 10 minutes, and the flash unit will then return to normal.
- When the over-temperature protection is started,  is shown on the screen.

Number of flashes that will activate over-temperature protection:

Power Output Level	Number of Flashes
1/1	80
1/2 (+0.7~+0.9)	105
1/2 (+0.3~+0.6)	125
1/2 (+0.0~+0.2)	160
1/4 (+0.7~+0.9)	185
1/4 (+0.3~+0.6)	245
1/4 (+0.0~+0.2)	320
1/8 (+0.7~+0.9)	375
1/8 (+0.3~+0.6)	490
1/8 (+0.0~+0.2)	640
1/16(+0.0 ~ +0.9)	800
1/32(+0.0 ~ +0.9)	1065

Power Output Level	Number of Flashes
1/64(+0.0 ~ +0.9)	1065
1/128(+0.0 ~ +0.9)	2100
1/256(+0.0 ~ +0.9)	2100
1/512(+0.0 ~ +0.9)	2100

Number of flashes that will activate over-temperature protection in high-speed sync triggering mode:

Power Output Level	Number of Flashes
1/1	50
1/2(+0.0 ~ +0.9)	60
1/4(+0.0 ~ +0.9)	80
1/8(+0.0 ~ +0.9)	105
1/16(+0.0 ~ +0.9)	128
1/32(+0.0 ~ +0.9)	160
1/64(+0.0 ~ +0.9)	
1/128(+0.0 ~ +0.9)	
1/256(+0.0 ~ +0.9)	210

2. Other Protections

The system provides real-time protection to secure the device and your safety. The following lists prompts for your reference:

Display	Meaning
Error1	A failure occurs on the recycling system so that the flash cannot fire. Please restart the flash unit. If the problem still exists, please send this product to a maintenance center.
Error3	The voltage on two outlets of the flash tube is too high. Please send this product to a maintenance center.
Error9	There are some errors occurred during the upgrading process. Please using the correct firmware upgrade method.

Technical Data

Model	AD600ProII
Wireless Receiver Unit Mode	Wireless Mode (compatible with Canon E-TTL II, Nikon i-TTL, Sony, Olympus, Panasonic, Fujifilm, Leica, Pentax)
Flash Mode	Wireless off: M/Multi Wireless receiver mode: TTL/M/Multi
Guide No. (1/1 step)	87 (ISO 100, in meters, with efficient reflector)
Flash Duration (t=0.1)	Normal: 1/220s ~ 1/11760s Color: 1/220s ~ 1/7400s Freeze: 1/2570s ~ 1/20400s
Power (1/1 step)	600Ws
Power Output	10 steps: 1/512 ~ 1/1 (with 0.1 increment each step)
Stroboscopic Flash	Provided (up to 100 times, 100Hz)
Sync Mode	High-speed sync (up to 1/8000 seconds), first-curtain sync, and second-curtain sync
Delay Flash	0.01 ~ 30s
Mask	✓
Fan	✓
Beep	✓
Flash Duration Indication	✓
Photocell	S1/S2/OFF
Display	Color screen
Modeling Lamp	
Max. Input Power	40W
Brightness Range	10%-100%
CRI	Average ≥ 97
TLCI	Average ≥ 98
CCT	2800K-6000K
Wireless Flash (2.4G transmission)	
Wireless Function	Receiver, Off
Controllable Receiver Groups	16: 0-9, A-F
Transmission Range	Approx. 100m
Channels	32: 1-32
ID	01-99/OFF

Power Supply	
Power Supply	Lithium battery(28.8V/2600mAh)
Full Power Flashes	360
Recycle Time	Approx. 0.01s ~ 0.9s
Battery Level Indicator	√
Power Saving	Auto off function is available in menu settings (30min to 120min of idle use)
Sync Triggering Mode	3.5mm sync cord
Flash Tube Color Temperature	5800±200K
Dimensions and Weights	
Dimension (with battery, without flash tube and reflector)	≈9.84"*9.65"*4.92"
Net Weight (with battery, without flash tube and reflector)	≈3kg

Specifications and data may subject to changes without notice.

Firmware Upgrade

- This flash supports firmware upgrade through the USB-C port. Update information will be released on our official website.
- Please use an USB-C cable (sold separately) for firmware upgrade.
- As the firmware upgrade needs the support of Godox G3 software, please download and install the "Godox G3 firmware upgrade software" from Godox official website before upgrading. Then, choose the related firmware file.
- Please refer to the latest electronic version of the instruction manual.

Maintenance

- Shut down the device immediately should abnormal operation be detected.
- Avoid sudden impacts and the product should be dedusted regularly.
- It is normal for the flash tube to be warm when in use. Avoid continuous flashes if unnecessary.
- Maintenance of the flash must be performed by our authorized maintenance department which can provide original accessories.
- This product, except consumables e.g. flash tube, is supported with a one-year warranty.
- Unauthorized service will void the warranty.
- If the product had failures or was wetted, do not use it until it is repaired by professionals.
- Changes made to the specifications or designs may not be reflected in this manual.

FCC Statement

This device complies with part 15 of the FCC Rules. Operation is subject to the following two conditions:

- (1) This device may not cause harmful interference, and
- (2) this device must accept any interference received, including interference that may cause undesired operation.

Any Changes or modifications not expressly approved by the party responsible for compliance could void the user's authority to operate the equipment.

Note: This equipment has been tested and found to comply with the limits for a Class B digital device, pursuant to part 15 of the FCC Rules. These limits are designed to provide reasonable protection against harmful interference in a residential installation. This equipment generates uses and can radiate radio frequency energy and, if not installed and used in accordance with the instructions, may cause harmful interference to radio communications. However, there is no guarantee that interference will not occur in a particular installation. If this equipment does cause harmful interference to radio or television reception, which can be determined by turning the equipment off and on, the user is encouraged to try to correct the interference by one or more of the following measures:

- Reorient or relocate the receiving antenna.
- Increase the separation between the equipment and receiver.
- Connect the equipment into an outlet on a circuit different from that to which the receiver is connected.
- Consult the dealer or an experienced radio/TV technician for help.

The device has been evaluated to meet general RF exposure requirement.

The device can be used in portable exposure condition without restriction.

Warning

Operating frequency:2412.99MHz – 2464.49MHz (only receive)

Declaration of Conformity

GODOX Photo Equipment Co.,Ltd. hereby declares that this equipment are in compliance with the essential requirements and other relevant provisions of Directive 2014/53/EU. In accordance with Article 10(2) and Article 10(10), this product is allowed to be used in all EU member states.For more information of DoC, Please click this web link:

<https://www.godox.com/eu-declaration-of-conformity/>

The device complies with RF specifications when the device used at 0mm from your body.

产品保修

尊敬的用户，本保修卡是申请保修服务的重要凭证，请您配合销售商填写并妥善保管，谢谢！

产品信息	型号	产品条码
用户信息	姓名	联系电话
	通信地址	
销售商信息	名称	
	联系电话	
	通信地址	
	销售日期	
备注		

注：此表应由销售商盖章确认。

产品信息

本文件适用于相关《产品保修信息》(见后面说明)所列产品,其他非属此范围的产品或部件(如促销品、赠品及其他出厂后附加的部件等)不在此保修承诺内。

保修期

产品及部件的相应保修期按相关的《产品保修信息》执行。保修期自产品首次购买日起算，购买日以购买产品时保修卡登记日期为准。

如何获得保修服务

您可直接与产品销售商或授权服务机构联系，也可拨打神牛产品售后服务电话，与我们联系，由我们的服务人员为您安排服务。申请保修时，您应提供有效的保修卡作为保修凭证，方可获得保修。如您不能提供有效的保修卡，则在我们确认产品或部件属于保修范围的情况下，也可以为您提供保修，但这不作为我们的义务。

不适用保修情况

如产品存在下列情况，本文件项下的保证和服务将不适用：①产品或部件超过相应保修期；②错误或不当使用、维护或保管导致的故障或损坏，如：不当搬运；非按产品合理预期用途使用；不当插拔外接设备；跌落或外力挤压；接触或暴露于不适当温度、溶剂、酸碱、水浸或潮湿环境；③由非神牛授权机构或人员安装、修理、更改、添加或拆卸造成的故障或损坏；④产品或部件原有识别信息被修改变更或删除；⑤无有效保修卡；⑥使用非合法授权、非标准或非公开发行的软件造成的故障或损坏；⑦因不可抗力或意外事件造成的故障或损坏；⑧其他非因产品本身质量问题导致的故障或损坏。遇上述情况，您应向相关责任方寻求解决，神牛对此不承担任何责任。因非在保修期或保修范围内的部件、附件或软件导致产品不能正常使用的，不是保修范围内的故障。产品使用过程中正常的脱色，磨损和消耗，不是保修范围内的故障。

产品保修和服务支持信息

产品的保修期和服务类型按以下《产品保修信息》执行：

产品类别	选件名称	保修期（月）	保修服务类型
部件	电路板	12	客户送修
	电池	3	客户送修
	充电器等带电性能的部件。	12	客户送修
其他	如外壳、保护罩、锁紧装置、包装等。	无	无保修

神牛产品售后服务电话 0755-29609320-8062

Warranty

Dear customers, as this warranty card is an important certificate to apply for our maintenance service, please fill in the following form in coordination with the seller and safe-keep it. Thank you!

Product Information	Model	Product Code Number
Customer Information	Name	Contact Number
	Address	
Seller Information	Name	
	Contact Number	
	Address	
	Date of Sale	
Note		

Note: This form shall be sealed by the seller.

Applicable Products

Applicable Products The document applies to the products listed on the Product Maintenance Information (see below for further information). Other products or accessories (e.g. promotional items, giveaways and additional accessories attached, etc.) are not included in this warranty scope.

Warranty Period

The warranty period of products and accessories is implemented according to the relevant Product Maintenance Information. The warranty period is calculated from the day (purchase date) when the product is bought for the first time, and the purchase date is considered as the date registered on the warranty card when buying the product.

How to Get the Maintenance Service

If maintenance service is needed, you can directly contact the product distributor or authorized service institutions. You can also contact the Godox after-sale service call and we will offer you service. When applying for maintenance service, you should provide valid warranty card. If you cannot provide valid warranty card, we may offer you maintenance service once confirmed that the product or accessory is involved in the maintenance scope, but that shall not be considered as our obligation.

Inapplicable Cases

The guarantee and service offered by this document are not applicable in the following cases: ① The product or accessory has expired its warranty period; ② Breakage or damage caused by inappropriate usage, maintenance or preservation, such as improper packing, improper usage, improper plugging in/out external equipment, falling off or squeezing by external force, contacting or exposing to the improper temperature, solvent, acid, base, flooding and damp environments, etc; ③ Breakage or damage caused by non-authorized institution or staff in the process of installation, maintenance, alternation, addition and detachment; ④ The original identifying information of product or accessory is modified, alternated, or removed; ⑤ No valid warranty card; ⑥ Breakage or damage caused by using illegally authorized, nonstandard or non-public released software; ⑦ Breakage or damage caused by force majeure or accident; ⑧ Breakage or damage that could not be attributed to the product itself. Once met these situations above, you should seek solutions from the related responsible parties and Godox assumes no responsibility. The damage caused by parts, accessories and software that beyond the warranty period or scope is not included in our maintenance scope. The normal discoloration, abrasion and consumption are not the breakage within the maintenance scope.

Maintenance and Service Support Information

The warranty period and service types of products are implemented according to the following Product Maintenance Information:

Product Type	Name	Maintenance Period(month)	Warranty Service Type
Parts	Circuit board	12	Customer sends the product to designated site
	Battery	3	Customer sends the product to designated site
	Electrical parts e.g.battery charger, etc.	3	Customer sends the product to designated site
Other Items	Lamp body, lamp cover, locking device, package, etc.	No	Without warranty

Godox After-sale Service Call +86-755-29609320(8062)