

705-LC500R-03

#### Warning

Operating frequency:2412.99MHz – 2464.49MHz (only receive)

#### Declaration of Conformity

GODOX Photo Equipment Co.,Ltd. hereby declares that this equipment are in compliance with the essential requirements and other relevant provisions of Directive 2014/53/EU. In accordance with Article 10(2) and Article 10(10), this product is allowed to be used in all EU member states.For more information of DoC, Please click this web link:  
[https://www.godox.com/DOC/Godox\\_LC500R\\_DOC.pdf](https://www.godox.com/DOC/Godox_LC500R_DOC.pdf)  
The device complies with RF specifications when the device used at 0mm from your body.

合格证  
QC PASS

#### 深圳市神牛摄影器材有限公司

地址: 深圳市宝安区福海街道塘尾社区耀川工业区厂房2栋  
电话: 0755-29609320(8062) 传真: 0755-25723423 邮箱: [godox@godox.com](mailto:godox@godox.com)

#### GODOX Photo Equipment Co., Ltd.

Add: Building 2, Yaochuan Industrial Zone, Tangwei Community, Fuhai Street, Bao'an District, Shenzhen, China Tel: +86-755-29609320(8062) Fax: +86-755-25723423  
E-mail: [godox@godox.com](mailto:godox@godox.com)

[godox.com](http://godox.com)

Made in China



# Godox

RGB LED棒灯  
RGB LED Light Stick

## LC500R

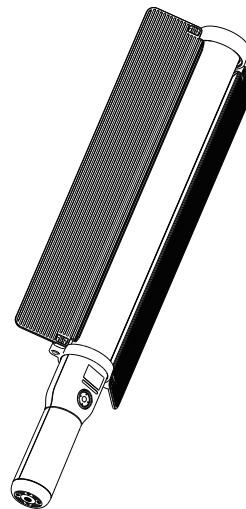

说明手册  
INSTRUCTION MANUAL

## Foreword

Thank you for purchasing this Godox Product!

This RGB LED Light Stick LC500R is a continuous light with high light brightness, wireless adjustment and multiple modes. Suitable for almost all shooting occasions e.g. live, camping, make up, portrait shooting, make up, video, wedding, children photography, etc. It's portable and easy to be operated.

### Features:

- Freely switch LED bicolor mode, colorful light mode and 39 situational special effects modes
- Easy to adjust color temperature, light brightness, hue and color saturation
- Blink and change colors with the rhythm of music
- With a display to clearly show the parameters
- With easy operation and wide application

## ⚠ Warning

- ⚠ Always keep this product dry. Do not use in rain or in damp conditions.
- ⚠ Do not disassemble. Should repairs become necessary, this product must be sent to an authorized maintenance center.
- ⚠ Keep out of reach of children.
- ⚠ As this product do not have waterproof function, please take measures of waterproof in rainy or damp environment.
- ⚠ Do not use the flash unit in the presence of flammable gases, chemicals and other similar materials. In certain circumstance, these materials may be sensitive to the strong light emitting from this flash unit and fire or electromagnetic interference may result.
- ⚠ As this product has built-in lithium battery, do not disassemble, impact, squeeze or put it into fire. If serious bulge occurs, please do not use. Do not use or store the product if the ambient temperature reads over 50°C. Please charge the product with specialized charger and correctly operate it within the defined voltage and working temperate according to the instruction manual.

## Parts

### • Body

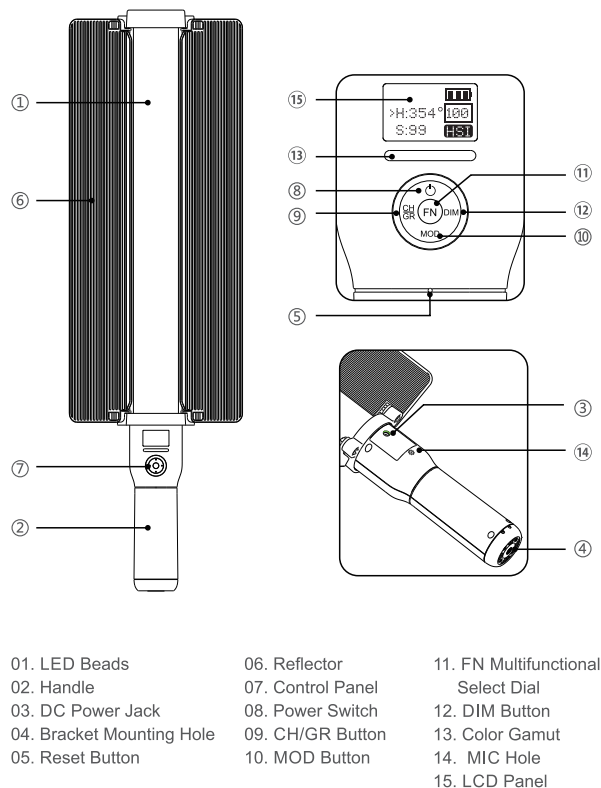

• LCD Panel

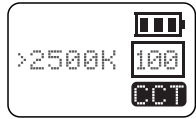

CCT: Bicolor Modes

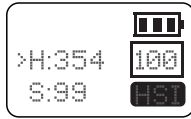

HSI: Colorful Light Modes

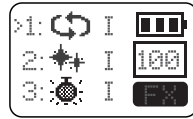

FX: Situational Special Effects Modes

Included Items

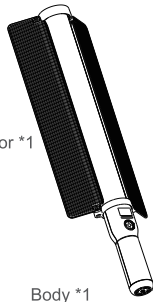

Reflector \*1

Body \*1



Charger(16.8V/1.2A) \*1



Portable Bag \*1

Battery Management

1. Power Supply

With built-in Li-polymer battery which can offer about 1.5 hours'lighting in 100% brightness once got fully charged.

2. Charge

The whole charging takes about 2.5 hours. The charge indicator turns to red in charging while green once got fully charged.

Attaching Reflector

**Installation:** Choose the side which needs reflector and adjust the reflector's direction. Match the ridge in the reflector's handle ring with the groove on the handle(as shown) and slip the reflector over the LED ice light and push in. Extend the reflector for shooting.



**Detachment:** Hold the handle and push the reflector from the bottom up to detach.



# Operation

## 1. Setting

### 1.1 Power On/Off

Long press the  to power on/off the LED light and the current information will be displayed on the LCD panel.



**1.2 Mode Selection:** Bicolor Mode/Colorful Mode/Situational Special Effects Mode. Press MOD button to switch different modes: CCT displayed on the screen means bicolor mode, HIS displayed on the screen means colorful mode and FX means situational special effects mode.

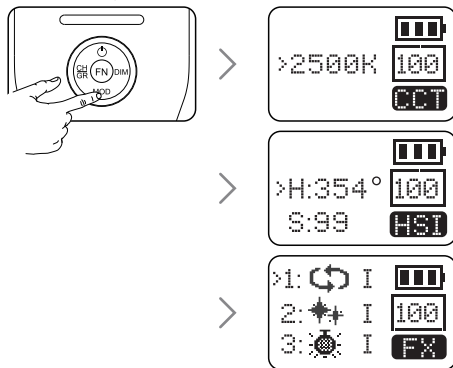

## 2. Wireless Remote Control

With 2.4G wireless system, this product has remote grouping and control function. Up to 6 groups of LED light stick can be controlled. 16 channels are available with strong anti-interference capability.

Please set the channels and groups of LED ice light to the same as those of remote control before usage.

Channel/Group/ID Setting: Press CH/GR to enter the setting interface.

**Note:** Remote control purchased separately

**2.1 Channel setting:** press the FN button to choose CH and turn the select dial to choose channel value from 1 to 32.

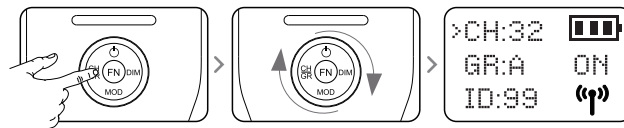

**2.2 Group setting:** press the FN button to choose GR and turn the select dial to choose group value from A to F.

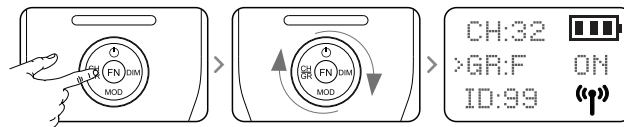

**2.3 ID setting:** press the FN button to choose ID and turn the select dial to choose ID from 1 to 99.

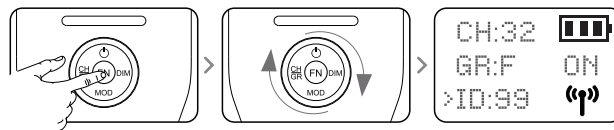

**2.4 Turn on/off the wireless:** press the FN button to choose  and turn the select dial to turn on or off the wireless.

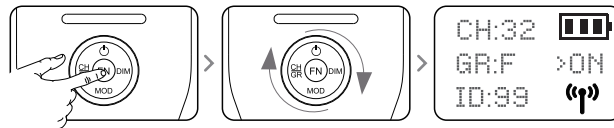

### 3. Bicolor Mode

**3.1 Color temperature adjustment:** turn the FN multifunctional select dial to adjust the color temperature from 2500K to 8500K.

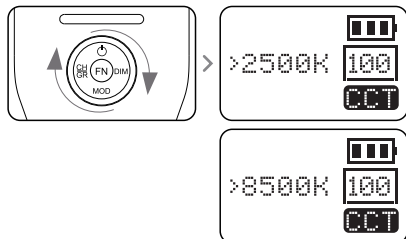

**3.2 Light brightness adjustment:** press the DIM button and the brightness value will be blinking. Turn the select dial to adjust the value from 0 to 100%.

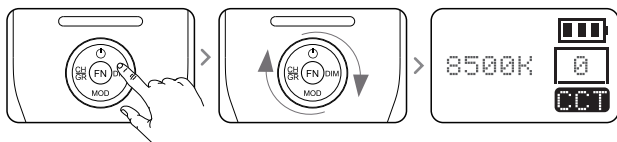

**3.3 P mode:** press the FN button and P will be displayed on the LCD panel, which means P mode. In P mode, the brightness will be change with the color temperature and reach the maximum value when color temperature is 4500K. In general mode, the brightness will keep the same when adjusting the color temperature.

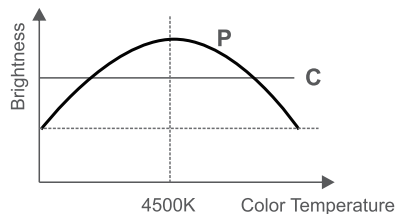

### 4. Colorful Mode

Press MOD button to enter setting interface.

**4.1 Adjust hue H:** press the FN multifunctional select dial and H is selected. Turn the FN multifunctional select dial to adjust the hue from 0 to 360°.

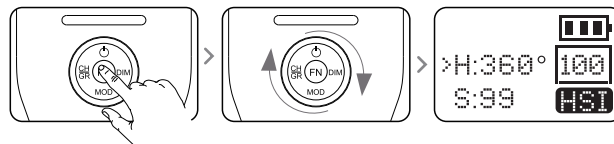

**4.2 Adjust saturation S:** press the FN multifunctional select dial and S is selected. Turn the FN multifunctional select dial leftwards or rightwards to adjust the saturation from 0 to 100.

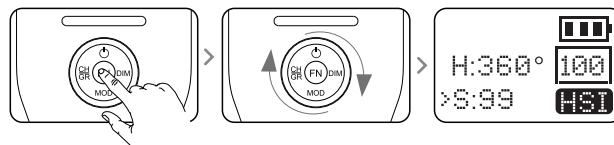

**4.3 Adjust light brightness:** press the DIM button and turn the select dial to adjust the brightness from 0~100%.

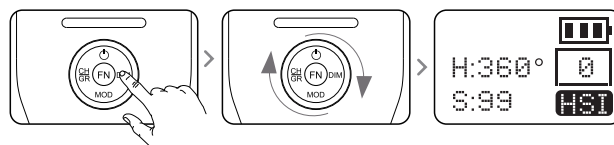

## 5. FX Situational Special Effects Mode(39 kinds)

5.1 Turn the select dial to choose different special effects modes from 1 to 14. And the modes will display circularly by turning the select dial.



5.2 After choosing the current mode, press down the FN multifunctional select dial from I, II and III. And the modes will display circularly when keeping pressing the FN multifunctional select dial.

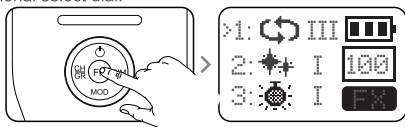

5.3 Adjust light brightness: turn the light brightness select dial to adjust from 0 to 100%.

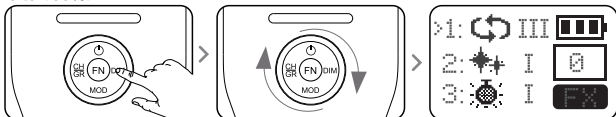

5.4 There're 39 kinds of situational special effects mode which are divided into 14 categories for your choice.

No.	Display	Situation	Display I	Display II	Display III
1	[Recycle icon]	Colorful lights recycle	Slow speed	Medium speed	Quick speed
2	[Flash icon]	Flash	Flash	Press conference	Paparazzi
3	[Laser icon]	Laser colorful lights	Birthday party	KTV	Disco
4	[Lightning icon]	Lightning	Discontinuous	Frequent	Sustainable
5	[Broken bulb icon]	Broken bulb	Discontinuous	Frequent	Sustainable
6	[TV icon]	TV	Slow speed	Medium speed	Quick speed
7	[Candle icon]	Candle	Discontinuous	Frequent	Sustainable
8	[Fire icon]	Fire	Firewood	Campfire	Fire hazard
9	[Firework icon]	Firework	Brief	Continuous	Show
10	[Police car icon]	Police car	Strong flash	Frequent flash	Quick flash
11	[Fire truck icon]	Fire truck	Strong flash	Frequent flash	Quick flash
12	[Ambulance icon]	Ambulance	Strong flash	Frequent flash	Quick flash
13	[Music icon]	Music	Music I	Music II	
14	[SOS icon]	SOS			

## Technical Data

Model	LC500R
Built-in Lithium Battery	14.4V/2600mAh lithium battery
Power	Max. 23W
Channel	32
Group	6 ( A B C D E F )
Color Temperature Range	2500K ~ 8500K
Light Brightness Range	0%~100%
RGB Color Gamut	0 ~ 360°
100% Light Brightness(LUX)	Max. 5800
CRI(≈)	96
TLCI(≈)	98
Duration(continuous output in 100% full power)(≈)	Approx. 90 minutes
Operation Temperature	-10~40 °C
Dimension (without reflector)	616*56*56mm
Net Weight (without reflector)	0.81Kg

\* Product design and specifications are subject to change without notice.

## FCC Statement

This device complies with part 15 of the FCC Rules. Operation is subject to the following two conditions: (1) This device may not cause harmful interference, and (2) this device must accept any interference received, including interference that may cause undesired operation.

**Note:** This equipment has been tested and found to comply with the limits for a Class B digital device, pursuant to part 15 of the FCC Rules. These limits are designed to provide reasonable protection against harmful interference in a residential installation. This equipment generates uses and can radiate radio frequency energy and, if not installed and used in accordance with the instructions, may cause harmful interference to radio communications. However, there is no guarantee that interference will not occur in a particular installation. If this equipment does cause harmful interference to radio or television reception, which can be determined by turning the equipment off and on, the user is encouraged to try to correct the interference by one or more of the following measures:

- Reorient or relocate the receiving antenna.
- Increase the separation between the equipment and receiver.
- Connect the equipment into an outlet on a circuit different from that to which the receiver is connected.
- Consult the dealer or an experienced radio/TV technician for help.

## 产品保修

尊敬的用户，本保修卡是申请保修服务的重要凭证，请您配合销售商填写并妥善保管，谢谢！

产品信息	型号	产品条码
用户信息	姓名	联系电话
	通信地址	
销售商信息	名称	
	联系电话	
	通信地址	
	销售日期	
备注		

注：此表应由销售商盖章确认。

### 如何获得保修服务

要保修服务，您可直接与产品销售商或授权服务机构联系，也可拨打神牛产品售后服务电话，与我们联系，由我们的服务人员为您安排服务。申请保修时，您应提供有效的保修卡作为保修凭证，方可获得保修。如您不能提供有效的保修卡，则在我们可确认产品或部件属于保修范围的情况下，也可以为您提供保修，但这不作为我们的义务。

### 不适用保修的情况

如产品存在下列情况，本文件项下的保证和服务将不适用 ①产品或部件超过相应保修期；②错误或不适当使用、维护或保管导致的故障或损坏，如：不当搬运；非按产品合理预期用途使用；不当插拔外接设备；跌落或外力挤压；接触或暴露于不当温度、溶剂、酸碱、水浸或潮湿环境；③由非神牛授权机构或人员安装、修理、更改、添加或拆卸造成的故障或损坏；④产品或部件原有识别信息被修改变更或删除；⑤无有效保修卡；⑥使用非合法授权、非标准或非公开发行的软件造成的故障或损坏；⑦因不可抗力或意外事件造成的故障或损坏；⑧其他非因产品本身质量问题导致的故障或损坏。遇上述情况，您应向相关责任方寻求解决，神牛对此不承担任何责任。因非在保修期或保修范围内的部件、附件或软件导致产品不能正常使用的，不是保修范围内的故障。产品使用过程中正常的脱色，磨损和消耗，不是保修范围内的故障。

### 产品保修和服务支持信息

产品的保修期和服务类型按以下《产品保修信息》执行：

产品类别	选件名称	保修期(月)	保修服务类型
部件	电路板	12	客户送修
	电池	3	客户送修
	充电器、电源线、同步线等带电性能的部件。	12	客户送修
其他	如闪光灯管、造型灯泡、外壳、保护罩、锁紧装置、包装等。	无	无保修

### 适用产品

本文件适用于相关《产品保修信息》(见后面说明)所列产品，其他非属此范围的产品或部件(如促销品、赠品及其他出厂后附加的部件等)不在此保修承诺内。

### 保修期

产品及部件的相应保修期按相关的《产品保修信息》执行。保修期自产品首次购买日起算，购买日以购买产品时保修卡登记日期为准。

神牛产品售后服务电话 0755-29609320-8062

# Warranty

Dear customers, as this warranty card is an important certificate to apply for our maintenance service, please fill in the following form in coordination with the seller and safekeep it. Thank you!

Product Information	Model	Product Code Number
Customer Information	Name	Contact Number
	Address	
Seller Information	Name	
	Contact Number	
	Address	
	Date of Sale	
Note:		

Note: This form shall be sealed by the seller.

## Applicable Products

The document applies to the products listed on the **Product Maintenance Information** (see below for further information). Other products or accessories (e.g. promotional items, giveaways and additional accessories attached, etc.) are not included in this warranty scope.

## Warranty Period

The warranty period of products and accessories is implemented according to the relevant Product Maintenance Information. The warranty period is calculated from the day (purchase date) when the product is bought for the first time. And the purchase date is considered as the date registered on the warranty card when buying the product.

## How to Get the Maintenance Service

If maintenance service is needed, you can directly contact the product distributor or authorized service institutions. You can also contact the Godox after-sale service call and we will offer you service. When applying for maintenance service, you should provide valid warranty card. If you cannot provide valid warranty card, we may offer you maintenance service once confirmed that the product or accessory is involved in the maintenance scope, but that shall not be considered as our obligation.

## Inapplicable Cases

The guarantee period and service offered by this document are not applicable in the following cases: ①. The product or accessory has expired its warranty period; ②. Breakage or damage caused by inappropriate usage, maintenance or preservation, such as improper packing, improper usage, improper plugging in/out external equipment, falling off or squeezing by external force, contacting or exposing to the improper temperature, solvent, acid, base, flooding and damp environments, etc; ③. Breakage or damage caused by non-authorized institution or staff in the process of installation, maintenance, alteration, addition and detachment; ④. The original identifying information of product or accessory is modified, alternated, or removed; ⑤. No valid warranty card; ⑥. Breakage or damage caused by using illegally authorized, nonstandard or non-public released software; ⑦. Breakage or damage caused by force majeure or accident; ⑧. Breakage or damage that could not be attributed to the product itself. Once met these situations above, you should seek solutions from the related responsible parties and Godox assumes no responsibility. The damage caused by parts, accessories and software that beyond the warranty period or scope is not included in our maintenance scope. The normal discoloration, abrasion and consumption are not the breakage within the maintenance scope.

## Maintenance and Service Support Information

The warranty period and service types of products are implemented according to the following **Product Maintenance Information**:

Product Type	Name	Maintenance Period(month)	Warranty Service Type
Parts	Circuit Board	12	Customer sends the product to designated site
	Battery	3	Customer sends the product to designated site
	Electrical parts e.g. battery charger, power cord, sync cable, etc.	12	Customer sends the product to designated site
Other Items	Flash tube, modeling lamp, lamp body, lamp cover, locking device, package, etc.	No	Without warranty

Godox After-sale Service Call **0755-29609320-8062**